

2012 International Conference on Applied Physics and Industrial Engineering

## LQR self-adjusting based control for the planar double inverted pendulum

Jiao-long Zhang, Wei Zhang

*School of Electrical Engineering & Automation, Henan Polytechnic University, Jiaozuo, China*

---

### Abstract

Firstly, the mathematical model of planar double inverted pendulum was established by means of analytical dynamics method. Based on the linear quadratic optimal theory, LQR self-adjusting controller was presented with optimize factor. Further the output of LQR controller is refined through optimize factor which is the function of the states of planar pendulum, and on account of that, control action exerted on the pendulum is improved. Simulation results together with pilot scale experiment verify the efficacy of the suggested scheme. The results show that the controller designed is simple and real-time is good in the lab. Moreover it can ensure fast response, good stability and robustness in the different operating conditions.

© 2011 Published by Elsevier B.V. Selection and/or peer-review under responsibility of ICAPIE Organization Committee.  
Open access under [CC BY-NC-ND license](http://creativecommons.org/licenses/by-nc-nd/3.0/).

Keywords: planar double inverted pendulum, LQR self-adjusting, optimize factor

---

### 1. Introduction

Inverted pendulum system has the characteristics of nonlinear, redundancy, uncertainty, strong coupling and the natural characteristics of instability. All these features make it the ideal model of advanced control theory and typical experiment platform of test control results. With the development of control theory, fuzzy control, variable structure control, energy control<sup>[1-3]</sup>, adaptive control methods are generally accepted. In recent years, compound control combined several control methods become central issue of inverted pendulum control research, and can take full advantage of their strengths. Scholars from various countries has done many studies<sup>[4-6]</sup> on inverted pendulum control, These control methods have some limitations, At the same time more complex control algorithm, the worse the effect of real-time control, will also increase the difficulties of implementation.

This paper analyzes the characteristics of planar inverted pendulum, based on the linear quadratic optimal theory, optimal controller is designed. Only in control of this controller, control effect of the inverted pendulum is not good enough, LQR self-adjusting controller with optimize factor is presented. It automatically adjust the size of control according to actual conditions, further the output of the LQR controller is refined through optimize factor, which is the function of the states of planar pendulum, and

control action exerted on the pendulum is improved. It is easy to achieve stable control of inverted pendulum.

**2.Mathematical model of inverted pendulum**

This object of study is Googol company GPIP2002 planar inverted pendulum. The mathematical model of planar double inverted pendulum is established by means of analytical dynamics method, Inverted pendulum system is mainly made up of controlled object, the direction of horizontal rails, servo motor, drive shaft and electric drive equipment. Control object is composed of the car, the downside pendulum, the upside pendulum, and two rotation shafts which connected to the car and pendulums, and shown in Fig. 1. Based on the fulcrums of pendulum, coordinates  $o_1x_1y_1z_1$  and  $o_2x_2y_2z_2$  are established. In condition of ignore effects of air resistance and friction, etc. Planar inverted pendulum can seen as be comprised of car platform, shaft mass, the uniform downside pendulum and the uniform upside pendulum.

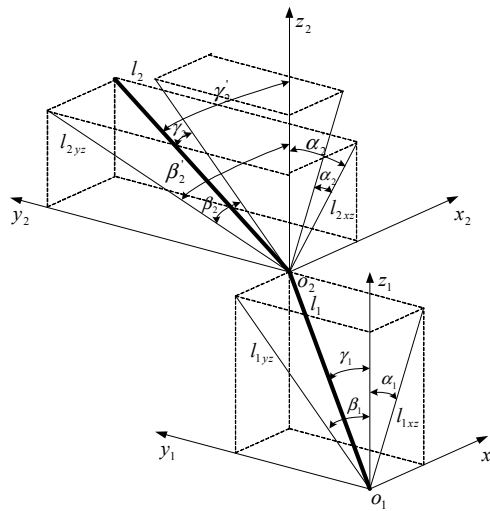

Figure 1. Schematic of planar double inverted pendulum.

The basic parameters are defined as follows:  $l_1, l_2$  are the length of the downside pendulum and the upside pendulum respectively.  $m_1, m_2$  are the quality of the downside pendulum and the upside pendulum respectively.  $m_3$  is the quality of link mass which link to the pendulum.  $M_x, M_y$  are the quality of the platform motion part and swing bearing of X direction and Y direction respectively. Specific values are:  $l_1=0.2m, l_2=0.55m, m_1=0.06kg, m_2=0.13kg, m_3=0.27kg, g=9.8 m / s^2$ .

In this paper, differential equation of inverted pendulum system is established by the Lagrange equation<sup>[7]</sup>, Lagrange operator as follows:

$$L(q, \dot{q}) = T(q, \dot{q}) - V(q, \dot{q}) \tag{1}$$

where  $q$  is generalized coordinate of system.  $T$  is kinetic energy of the system.  $V$  is potential energy of the system. From the generalized coordinates  $q$  and  $L$ , Lagrange equations can be expressed as:

$$\frac{d}{dt} \frac{\partial L}{\partial \dot{q}_i} - \frac{\partial L}{\partial q_i} = \tau_i \tag{2}$$

where  $i$  is system variable label,  $i = 1, 2, \dots, n$ ,  $q = \{q_1, q_2, q_3, \dots\}$  is generalized variable,  $\tau_i$  are system generalized external forces of along the direction of generalized coordinate. For planar double inverted pendulum, the generalized coordinates are:  $x, y, \alpha_1, \beta_1, \alpha_2, \beta_2$ . The total kinetic energy of the system is:

$$T = T_M + T_{m_1} + T_{m_2} + T_{m_3}$$

$$V = V_M + V_{m_1} + V_{m_2} + V_{m_3}$$

The total potential energy of the system is:

Relevant parameters are used in (1), Since the external forces of the generalized coordinates  $\alpha_1, \beta_1, \alpha_2, \beta_2$  is zero, and equations can be established by (2).  $\ddot{\alpha}_1, \ddot{\beta}_1, \ddot{\alpha}_2, \ddot{\beta}_2$  are worked out. In the equilibrium position ( $q=\dot{q}=0$ ), the Taylor series expansion of  $\ddot{\alpha}_1, \ddot{\beta}_1, \ddot{\alpha}_2, \ddot{\beta}_2$  and linearization are executed, parameter values are brought into, decoupled state equations in X and Y directions of double inverted pendulums respectively are solved.

$$\begin{cases} \dot{X}_x = A_x X_x + B_x u_x \\ Y_x = C_x X_x \end{cases} \tag{3}$$

$$\begin{cases} \dot{X}_y = A_y X_y + B_y u_y \\ Y_y = C_y X_y \end{cases} \tag{4}$$

where control actions of X and Y direction are  $u_x = \ddot{x}$ ,  $u_y = \ddot{y}$ , State variables are:

$$X_x = [x, \alpha_1, \alpha_2, \dot{x}, \dot{\alpha}_1, \dot{\alpha}_2]^T,$$

$$X_y = [y, \beta_1, \beta_2, \dot{y}, \dot{\beta}_1, \dot{\beta}_2]^T.$$

$$A_x = \begin{pmatrix} 0 & 0 & 0 & 1 & 0 & 0 \\ 0 & 0 & 0 & 0 & 1 & 0 \\ 0 & 0 & 0 & 0 & 0 & 1 \\ 0 & 0 & 0 & 0 & 0 & 0 \\ 0 & 50.2235 & -14.7272 & 0 & 0 & 0 \\ 0 & -50.8908 & 49.4875 & 0 & 0 & 0 \end{pmatrix}, B_x = \begin{pmatrix} 0 \\ 0 \\ 0 \\ 1 \\ -5.1248 \\ 5.1929 \end{pmatrix}, C_x = \text{diag}(1,1,1,1,1,1), A_y = A_x, B_y = B_x, C_y = C_x.$$

From state equations, linear models in X and Y directions of double inverted pendulums have been decoupled respectively, and can be controlled separately. Each system has one input, six outputs, the control object is greatly simplified. Controllability principle can be applied to verify the controllability of the system.

### 3.Design of LQR Self-adjusting controller

After Linearization of the mathematical models, linear optimal control theory is applied to design LQR controller for the state equation of X direction<sup>[8]</sup>. Y direction uses the same control algorithm. For the form as (3), state feedback control can be find:

$$u(t) = -Kx(t) \tag{5}$$

So as to minimize the performance index function

$$J = \frac{1}{2} \int_0^{T_f} [x^T(t)Qx(t) + u^T(t)Ru(t)]dt \tag{6}$$

where  $Q$  is semi-definite matrix,  $R$  is positive definite matrix,  $Q$  and  $R$  are the weighting matrixes of state variables and input variables respectively. For the smallest performance index function, at first Hamilton function is constructed, derivation of this function was obtained and make it equal to zero, which can determine the optimal control rate:

$$u(t) = -Kx(t) = -R^{-1}B^T Px(t) \tag{7}$$

where  $P$  is the only positive definite symmetric solution which meet the Riccati equation  $PA+ATP-PBR-1BTP+Q=0$ .

When the system is stable, inverted pendulum control objective is that the downside pendulum and the upside pendulum are upright, the car is at the central. So according to actual situation, control strategy should be stabilize the upside pendulum as a priority, the downside pendulum second, and final control car displacement. After extensive simulation, when  $Q=\text{diag}[200,300,400,1,1,1]$ ,  $R=1$ , by means of MATLAB simulation , LQR state feedback gain matrix is calculated, that is  $K=[14.14, 76.03, 191.54, 15.77, 29.53, 33.03]$ .

In general, LQR controller is designed on the basis of the weighting matrixes  $Q$  and  $R$ . system performance reach to optimal in such conditions. But there are ways to optimize its control action<sup>[9]</sup>.The output of the LQR controller is refined through optimize factor  $(a - be^{-|x|})$ , ( $a > 0, b > 0$ ) in this paper , and the basic principle is shown as Fig. 2. The controller can adjust the size of control action adaptively according to the change of state variables, and ensure that system have fast response and robustness.

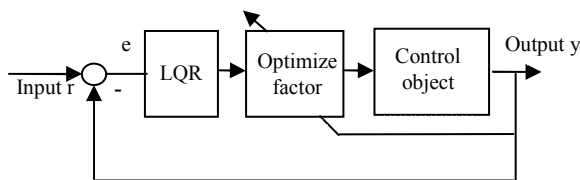

Figure 2. Schematic of LQR self-adjusting controller.

According to optimize factor expression  $(a - be^{-|x|})$ , when the system is unstable, state variable such as the upside pendulum angle will increase,  $e^{-|x|}$  also will decrease with it, and optimize factors will increase at this time and strengthen control action. This make for stabilize inverted pendulum faster. When the inverted pendulum gradually stabilized, state variable such as the upside pendulum angle will decrease  $e^{-|x|}$  also will increase with it, and optimize factors will decrease at this time and weaken control action.

This can avoid excessive vibration of inverted pendulum and reduce the system error. The system is more stable. But the parameters a and b in factor need to be optimized according to actual situation.

#### 4.Experimental results

##### 4.1.Simulation results

According to the state equation of inverted pendulum, simulation model can be constructed in the SIMULINK environment<sup>[10]</sup>. When State variable of optimize factor refer to the upside pendulum angle, at this time, and initial state Equal to zero, After several simulation, optimize factor ( $a - be^{-|x|}$ ) parameter  $a=1.95, b=0.5, K=[14.14, 76.03, 191.54, 15.77, 29.53, 33.03]$ , the displacement of car can track unit step signal, downside pendulum and upside pendulum reach to stable within the 3s. Simulation curves of car displacement, downside angle and upside angle are shown in Fig. 3, 4, 5.

Carry out square wave signal tracking experiment in the zero state conditions, square wave signal amplitude is 1m, frequency is 0.004Hz. The simulation curve of displacement is shown in Fig. 6. From the figure we can see that Fast response of LQR self-adjusting controller is better than general LQR controller and system have has better stability.

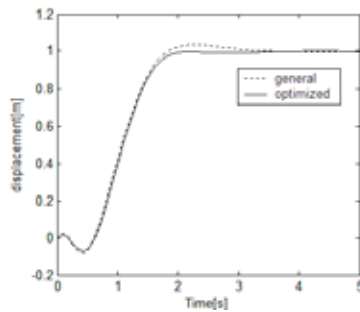

Figure 3. Simulation curves of displacement.

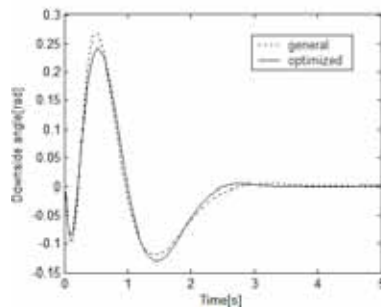

Figure 4. Simulation curves of downside angle

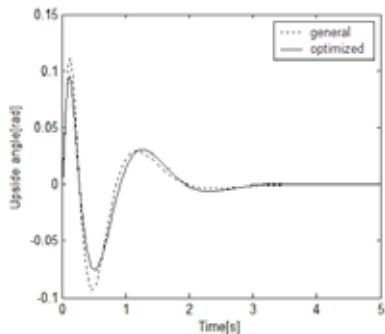

Figure 5. Simulation curves of upside angle.

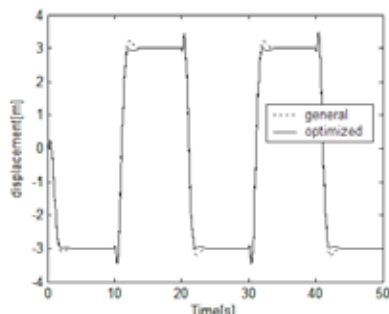

Figure 6. Simulation curves of displacement tracking square wave.

When the external disturbance is zero, and initial state is  $[0, 0.2, 0, 0, 0, 0]$ , at this time the downside angle is 0.2rad, car displacement and the upside angle are zero, response curves of system zero input are shown in Fig. 7.

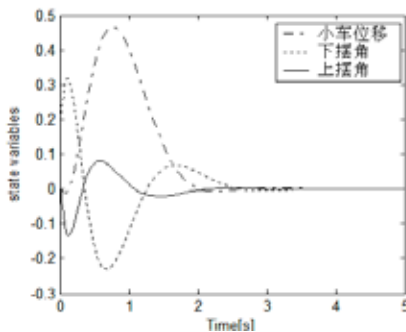

Figure 7. Simulation curves of state variables.

#### 4.2. Real-time results

Based on the simulation, real-time control test is implemented by using Real-Time Workshop (RTW) in SIMULINK. The control object is GPIP2002 inverted pendulum system. Dynamic Link Library (DLL), which are developed from interface MEX generated by Visual C++, is the communicate intermediary of MATLAB and PCI data acquisition card. Simulation model and M documents are drawn up to achieve the user's own control algorithm. Control parameters are modified easily.

Planar inverted pendulum has no ability to swing automatically, need to manually put up the pendulum to the equilibrium position. When real-time control module was to be started, release the pendulum pole after exert control action to car, the pendulum will maintain balance in control of computer. Fig.8, 9, 10 show real-time curves of displacement, downside angle and upside angle in control of LQR self-adjusting controller respectively, From the figure we can see that the displacement range is between  $[0.011, 0.019]$ m, the downside angle range is between  $[-0.02, 0.01]$ rad, the upside angle range is between  $[-0.015, 0.015]$ rad, control action  $u$  range is between  $[-30, 30]$ ,The controller has good control effect.

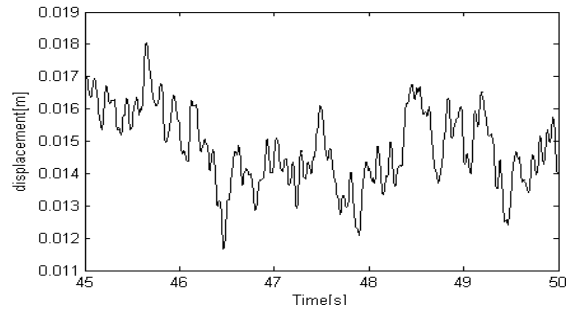

Figure 8. Real-time curves of displacement.

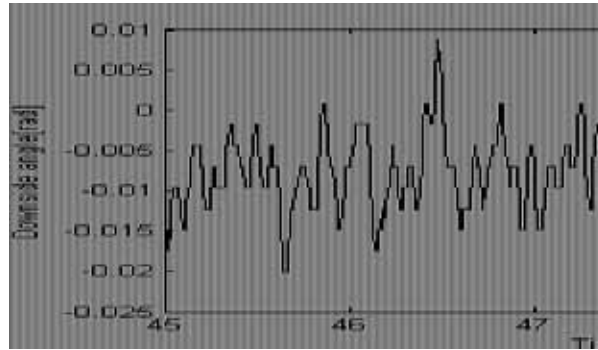

Figure 9. Real-time curves of downside angle.

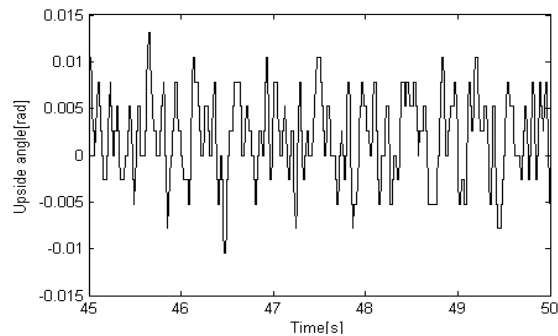

Figure 10. Real-time curves of upside angle.

## 5. Conclusions

The mathematical model of planar double inverted pendulum is established by means of Lagrange equation. LQR self-adjusting controller is proposed in this paper, and has good control effect. The simulation model is constructed in SIMULINK, which can reduce the programming effort and easily change the control parameters. This LQR self-adjusting controller has successfully achieved the control of inverted pendulum physical system by using RTW which calls dynamic link library. The controller this paper presented simplifies the control algorithm and has good real-time. Experimental results show the effectiveness of the design.

## References

- [1] Furuta K, Kajiwara H, Kosuge K. Digital control of a double inverted pendulum on an inclined rail. *Int. J. of Control*, 1980, 32(5):907-924.
- [2] Chen Wei Ji, Fang Lei, Lei Kam Kin. Fuzzy logic controller for an inverted pendulum system. *Proceedings of the IEEE International Conference on Intelligent Processing Systems, ICIPS*, 1998, 1:185-189.
- [3] Zhang Keqin, Su Hongye, Zhuang Kaiyu, Chu Jian. Robust control based on sliding mode for a triple inverted pendulum[J]. *Journal of Zhejiang University(Engineering Science)*, 2002, 36(4):404-409.
- [4] K. Yang Zhenqiang, Piao Guoying, Cheng Shukang. Control of double inverted pendulum by using state varieties synthesis fuzzy neural network[J]. *Control and Decision*, 2002, 22(1):123-128.
- [5] Li Hongxing, Miao Zhihong, Wang Jiayin. Variable universe adaptive fuzzy control of fourfold inverted pendulum[J]. *Science in China, Ser. E*, 2001, 32(1):65-75.
- [6] Luo Cheng, Hu Dewen, Zhu Xiaocai, Dong Guohua. Quintuple inverted pendulum control based on LQR and fuzzy piecewise interpolation[J]. *Control and Decision*, 2005, 20(4):392-397.
- [7] Song Junlie, Xiao Jun, Xu Xinhe. Modeling and Control Method of the Inverted Pendulum System[J]. *Journal of Northeastern University (Natural Science)*, 2002, 23(4):333-337.
- [8] Hu Shousong, Wang Zhiquan, Hu Weili. *The optimal control theory and system*[M]. Beijing: Science Press, 2005:162-180.
- [9] Duan Xuechao, Qiu Yuanying, Duan Baoyan. Adaptive sliding mode fuzzy control of planar inverted pendulum[J]. *Control and Decision*, 2007, 22(7):774-777.
- [10] Qu Jianling, Wu Wenhai, Sun Junen. Design and Simulation of the Fuzzy Controller for the Three Stage Inverted Pendulum[J]. *Journal of System Simulation*, 2004, 16(3):578-580.
- [11]