

Stable optimal control applied to a cylindrical robotic arm

César Torres · José de Jesús Rubio ·
Carlos F. Aguilar-Ibáñez · J. Humberto Pérez-Cruz

Received: 30 March 2012 / Accepted: 27 November 2012 / Published online: 29 December 2012
© Springer-Verlag London 2012

Abstract In this paper, an asymptotically stable optimal control is proposed for the trajectory tracking of a cylindrical robotic arm. The proposed controller uses the linear quadratic regulator method and its Riccati equation is considered as an adaptive function. The tracking error of the proposed controller is guaranteed to be asymptotically stable. A simulation shows the effectiveness of the proposed algorithm.

Keywords Optimal control · Cylindrical robotic arm · Stability

1 Introduction

The research about the robotic arms is classified into three kinds: the trajectory planning [10, 26] position estimation [1, 7, 30], and control [4, 6, 9, 19, 31]. This paper is focused on the control method.

There is some research about the control of robotic systems. In [4], the authors study how a self-organized

mobile robot flock can be steered toward a desired direction through externally guiding some of its members. In [6], an adaptive neural network sensorless control scheme for machines is introduced. In [9], a model-free self-tuning output recurrent cerebellar model articulation controller to control an inverted pendulum is investigated. In [19], they adopt a network structure developing a biologically plausible GRN model for robot control. In [31], a fault tolerant control of a robotic system is investigated. This paper proposes an alternative approach for the trajectory tracking of robotic arms which is the optimal control.

There is some work about optimal control of robotic systems. In [2], a new system incorporating optimal port placement planning is established. In [3], an optimization approach applied to mechanical linkage models is used to simulate human arm movements. In [5], the problem of motion planning has been dealt with fitting an optimal energy trajectory. In [12], an optimization framework is presented for non-symmetric gait cycles found in the presence of one-sided gait disorders. In [13], an optimal walking pattern is proposed to be tracked by a designed sliding mode controller. In [18], the purpose is to show how optimal control methods based on whole-body dynamic models of the diver can be very useful in generating natural platform diving motions. In [32], an optimal trajectory planning method with vibration reduction for a dual-arm space robot with front flexible links is proposed. In [33], an optimization approach is applied to a whole manipulation task as an example. Despite that the above works mention the optimal control, the stability issue is not addressed; in addition, in most of the cases, the optimization issue is considered instead of the linear quadratic regulator method.

In [11, 23], the authors introduce the linear quadratic regulator method which is mainly applied to linear systems. In this paper, the aforementioned method is modified to be

C. Torres · C. F. Aguilar-Ibáñez
Laboratorio de Robótica y Mecatrónica, CIC,
Instituto Politécnico Nacional, Av. Juan de Dios Batiz,
s/n Col. Zacatenco, 07738 Mexico, DF, Mexico

J. de Jesús Rubio (✉) · J. H. Pérez-Cruz
Sección de Estudios de Posgrado e Investigación, ESIME
Azcapotzalco, Instituto Politécnico Nacional, Av. de las Granjas
no. 682, Col. Santa Catarina, 02250 Mexico, DF, Mexico
e-mail: jrubioa@ipn.mx; rubio.josedejesus@gmail.com

J. H. Pérez-Cruz
Centro Universitario de Ciencias Exactas e Ingenierías,
Universidad de Guadalajara Boulevard Marcelino García
Barragán, No. 1421, 44430 Guadalajara, JAL, Mexico

applied for the tracking control of the robotic arms. In addition, the tracking error of the optimal control and the robotic arm is guaranteed to be asymptotically stable.

This paper is organized as follows. In Sect. 2, some important characteristics of the general robotic arms mathematical model are introduced. In Sect. 3, the optimal control applied to robotic arms is presented. In Sect. 4, the asymptotic stability of the tracking error of the optimal control for the trajectory tracking of robotics arms is guaranteed. In Sect. 5, the simulation of the optimal control applied to a cylindrical robotic arm is shown. In Sect. 6, the conclusion and the future research are detailed.

2 Preliminaries

The main concern of this section is to understand some concepts of robot dynamics. The equation of motion for the constrained robotic manipulator with n degrees of freedom, considering the contact force and the constraints, is given in the joint space as follows:

$$M(q)\ddot{q} + C(q, \dot{q})\dot{q} + G(q) = \tau \tag{1}$$

where $q \in \mathbb{R}^{n \times 1}$ denotes the joint angles or link displacements of the manipulator, $M(q) \in \mathbb{R}^{n \times n}$ is the robot inertia matrix which is symmetric and positive definite, $C(q, \dot{q}) \in \mathbb{R}^{n \times n}$ contains the centripetal and Coriolis terms and $G(q) \in \mathbb{R}^{n \times 1}$ are the gravity terms, and $\tau \in \mathbb{R}^{n \times 1}$ denotes the torque or the force.

Property 1 *The inertia matrix is symmetric and positive definite, that is, [24, 29]:*

$$m_1 |x|^2 \leq x^T M(x_1)x \leq m_2 |x|^2, \tag{2}$$

where m_1, m_2 are known positive scalar constants.

Property 2 *The centripetal and Coriolis matrix are skew-symmetric, that is, satisfies the following relationship [24, 29]:*

$$x^T (\dot{M}(x_1) - 2C(x_1, x_2))x = 0 \tag{3}$$

The centripetal and Coriolis matrix also satisfy the following [24, 29]:

$$\|C(x_1, x_2)x_2\| \leq k_c |x_2|^T, \tag{4}$$

where $k_c \in \mathbb{R}^n$.

Define the following two states and the input of the mathematical model for robotic arms of Eq. (1) as follows:

$$\begin{aligned} x_1 &= q \in \mathbb{R}^{n \times 1} \\ x_2 &= \dot{q} \in \mathbb{R}^{n \times 1} \\ u &= \tau \in \mathbb{R}^{n \times 1} \end{aligned} \tag{5}$$

Then, (1) can be rewritten as:

$$\begin{aligned} \dot{x}_1 &= x_2 \\ \dot{x}_2 &= M^{-1}(x_1)[\tau - G(x_1) - C(x_1, x_2)x_2] \end{aligned} \tag{6}$$

Remark 1 From (2), $M(x_1) > 0$, so $M^{-1}(x_1)$ exist and it is well used.

Substituting (6) into (1) gives the robotic arms mathematical model of this paper as follows:

$$\begin{aligned} \dot{x} &= Ax + B(u - G) \\ A &= \begin{bmatrix} 0 & I \\ 0 & -M^{-1}(x_1)C(x_1, x_2) \end{bmatrix} \\ B &= \begin{bmatrix} 0 \\ M^{-1}(x_1) \end{bmatrix} \end{aligned} \tag{7}$$

where $I \in \mathbb{R}^{n \times n}$ is the identity matrix, $x = [x_1, x_2]^T$, and x_1 and x_2 are given in (5).

3 Optimal control for the trajectory tracking

In this section, the optimal control will be designed for the trajectory tracking case where the objective is to obtain that the tracking error of the states converges to zero, that is, the states of the robotic arm converge to the desired trajectories.

The proposed optimal control of this paper is defined as follows:

$$u = G(x_1) + \hat{u} \tag{8}$$

where \hat{u} is the auxiliary optimal control which will be obtained later. Substituting (8) into (7) gives the modified robotic arms mathematical model as follows:

$$\dot{x} = Ax + B\hat{u} \tag{9}$$

where A and B are defined in (7).

Define the tracking error \tilde{x} as follows:

$$\tilde{x} = x - x_d \tag{10}$$

where x_d is the desired reference.

Define the reference model as follows:

$$\dot{x}_d = Ax_d \tag{11}$$

where \dot{x}_d is the derivative of the desired reference x_d , and A is defined in (7).

Subtracting (11) to (9) and using (10), the tracking error of the closed-loop system is obtained as follows:

$$\dot{\tilde{x}} = A\tilde{x} + B\hat{u} \tag{12}$$

where A and B are defined in (7).

Now, the auxiliary optimal control \hat{u} will be obtained. The quadratic performance index of the linear quadratic regulator for this system is [11, 23]:

$$J = \frac{1}{2} \tilde{x}_f^T H \tilde{x}_f + \frac{1}{2} \int_{t_0}^{t_f} (\tilde{x}^T Q \tilde{x} + \hat{u}^T R \hat{u}) dt \tag{13}$$

where $0 \leq H \in \mathbb{R}^{2n \times 2n}, 0 \leq Q \in \mathbb{R}^{2n \times 2n}, 0 < R \in \mathbb{R}^{n \times n}, \tilde{x} = [\tilde{x}_1, \tilde{x}_2]^T \in \mathbb{R}^{2n \times 1}$ are the states of the system, $\hat{u} \in \mathbb{R}^{n \times 1}$ is the input of the system, and \tilde{x}_f are the states at the end of the simulation.

The equations of the optimal control for the linear quadratic regulator method are as follows [11, 23]:

$$\begin{aligned} h(\tilde{x}, u, \lambda) &= \frac{1}{2} [\tilde{x}^T Q \tilde{x} + \hat{u}^T R \hat{u}] + \lambda^T [A\tilde{x} + B\hat{u}] \\ 0 &= \frac{\partial h(\tilde{x}, \hat{u}, \lambda)}{\partial u} \\ \dot{\tilde{x}} &= \frac{\partial h(\tilde{x}, \hat{u}, \lambda)}{\partial \lambda} \\ \dot{\lambda} &= -\frac{\partial h(\tilde{x}, \hat{u}, \lambda)}{\partial \tilde{x}} \end{aligned} \tag{14}$$

where $h(\tilde{x}, \hat{u}, \lambda) \in \mathbb{R}$ is the Hamiltonian, and $\lambda \in \mathbb{R}^{2n \times 1}$ is known as the co-state defined as:

$$\lambda = S\tilde{x} \tag{15}$$

where $0 < S \in \mathbb{R}^{2n \times 2n}$ matrix.

From the second equation of (14), we get

$$\frac{\partial h(\tilde{x}, \hat{u}, \lambda)}{\partial u} = R\hat{u} + B^T \lambda = 0 \tag{16}$$

Obtaining the auxiliary optimal control \hat{u} using (16) gives the following:

$$\hat{u} = -R^{-1} B^T \lambda = -R^{-1} B^T S \tilde{x} \tag{17}$$

Obtaining the derivative of (15) gives the following:

$$\dot{\lambda} = \dot{S}\tilde{x} + S\dot{\tilde{x}} \tag{18}$$

From the fourth equation of (14), we get

$$\dot{\lambda} = -Q\tilde{x} - A^T \lambda \tag{19}$$

Substituting first (18), later (9), then (17), and finally (15) into (19) gives the following:

$$[\dot{S} + Q - SBR^{-1}B^T S + SA + A^T S]\tilde{x} = 0 \tag{20}$$

The Eq. (20) can be rewritten as $a(x)b(x) = 0$, where $a(x) = \dot{S} + Q - SBR^{-1}B^T S + SA + A^T S$ and $b(x) = \tilde{x}$. Since $b(x)$ cannot be zero, then $a(x) = 0$; therefore, the Riccati matrix equation is obtained as follows [8, 11, 23]:

$$\dot{S} + Q - SBR^{-1}B^T S + SA + A^T S = 0 \tag{21}$$

Remark 2 The main control function of this study is (8) which contains the gravity terms. Therefore, the well known Eq. (17) is an auxiliary function of (8). In addition, (21) is considered in this study as an adaptive function, so

it is online solved at the same time than the controller works.

4 Stability of the optimal control

The following theorem presents the optimal control applied to robotic arms.

Theorem 1 *The tracking error of the closed-loop system with the optimal control (8), (17), and (21) for the robotic arm (8) is asymptotically stable and the tracking error \tilde{x} will converge to:*

$$\limsup_{T \rightarrow \infty} \tilde{x}^T (Q + SBR^{-1}B^T S)\tilde{x} = 0 \tag{22}$$

where T is the final time.

Proof The proposed Lyapunov function is

$$L_a = \frac{\gamma}{2} \tilde{x}^T S \tilde{x} \tag{23}$$

Substituting (17) into (12) gives the following:

$$\dot{\tilde{x}} = (A - BR^{-1}B^T S)\tilde{x} \tag{24}$$

The derivative of (23) is

$$\dot{L}_a = \frac{\gamma}{2} \tilde{x}^T S \dot{\tilde{x}} + \frac{\gamma}{2} \dot{\tilde{x}}^T S \tilde{x} + \frac{\gamma}{2} \tilde{x}^T \dot{S} \tilde{x} \tag{25}$$

Equation (21) can be rewritten as $\dot{S} = -Q + SR^{-1}B^T S - SA - A^T S$, and substituting \dot{S} and (24) into (25) gives the following:

$$\begin{aligned} \dot{L}_a &= \frac{\gamma}{2} \tilde{x}^T S ((A - BR^{-1}B^T S)\tilde{x}) \\ &\quad + \frac{\gamma}{2} ((A - BR^{-1}B^T S)\tilde{x})^T S \tilde{x} \\ &\quad + \frac{\gamma}{2} \tilde{x}^T (-Q + SR^{-1}B^T S - SA - A^T S)\tilde{x} \\ &= -\frac{\gamma}{2} \tilde{x}^T Q \tilde{x} - \frac{\gamma}{2} \tilde{x}^T SBR^{-1}B^T S \tilde{x} \end{aligned}$$

So:

$$\dot{L}_a = -\frac{\gamma}{2} \tilde{x}^T (Q + SBR^{-1}B^T S)\tilde{x} \tag{26}$$

From [27] and using (26), the tracking error is asymptotically stable. Integrating (26) from 0 to T yields the following:

$$\int_0^T \left[\frac{\gamma}{2} \tilde{x}^T (Q + SBR^{-1}B^T S)\tilde{x} \right] dt \leq L_{1,0} - L_{1,T} \leq L_{1,0}$$

$$\limsup_{T \rightarrow \infty} \frac{1}{T} \int_0^T \left[\frac{\gamma}{2} \tilde{x}^T (Q + SBR^{-1}B^T S)\tilde{x} \right] dt \leq L_{1,0} \limsup_{T \rightarrow \infty} \frac{1}{T} = 0$$

If $T \rightarrow \infty$, then $\tilde{x}^T(Q + SBR^{-1}B^TS)\tilde{x} = 0$; it is (22). \square

Remark 3 From (21), it is true that S is positive definite; therefore, the term $SBR^{-1}B^TS$ of (26) is positive definite assuring the main result of the aforementioned theorem.

Remark 4 [15–17] use the linear quadratic regulator method for their controllers, similar to this paper, but the Riccati equation of the three papers is solved in an inverse form using the final conditions, and in this paper the, Riccati equation is considered as an adaptive function being solved in a forward form using initial conditions.

5 Simulations

The proposed stable optimal controller will be compared with the proportional-integral-derivative (PID) method.

Figure 1 shows the cylindrical robotic arm. The Euler–Lagrangian method is used to obtain the robotic arm mathematical model. Table 1 shows the parameters of the cylindrical robotic arm.

The full expression for the dynamic system is [24]:

$$\begin{aligned} [J_{13} + (m_2 + 4m_3)l_{c2}^2]\ddot{\theta}_1 + 2(m_2 + 4m_3)l_{c2}\dot{\theta}_1\dot{l}_{c2} &= \tau_1 \\ (m_2 + 4m_3)\ddot{l}_{c2} - (m_2 + 4m_3)l_{c2}\dot{\theta}_1^2 &= \tau_2 \\ m_3\ddot{l}_{c3} - m_3g &= \tau_3 \end{aligned} \tag{27}$$

where τ_1 , τ_2 , and τ_3 are the torques used to move the links 1, 2, and 3, respectively, $q_1 = \theta_1$ is the angle of the rotation joint, and $q_2 = l_{c2}$ and $q_3 = l_{c3}$ are the length which grow until the center of mass of the links 2 and 3, respectively.

The dynamic model (27) can be rewritten in the joint space as in (1) where:

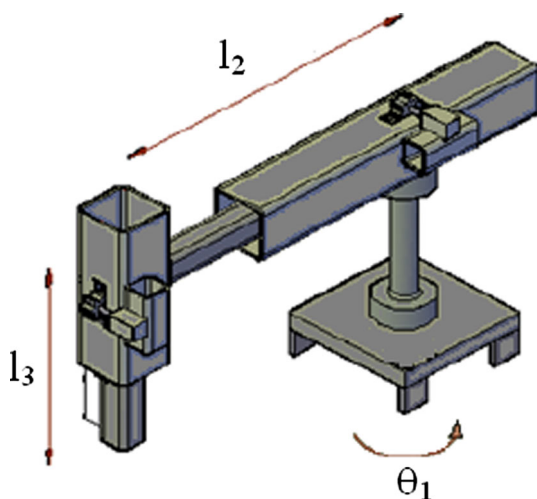

Fig. 1 Cylindrical robotic arm

Table 1 Parameters of a cylindrical arm

Parameter	Value	Unit
l_1	0.3	m
l_2	0.3	m
l_3	0.2	m
m_1	0.46	kg
m_2	0.34	kg
m_3	0.34	kg
J_1	0.04624	kg m ²
J_2	0.02545	kg m ²
J_3	0.03616	kg m ²

where $g = 9.81$

$$\begin{aligned} M(q) &= \begin{bmatrix} J_{13} + (m_2 + 4m_3)q_2^2 & 0 & 0 \\ 0 & m_2 + 4m_3 & 0 \\ 0 & 0 & m_3 \end{bmatrix} \\ C(q, \dot{q}) &= \begin{bmatrix} (m_2 + 4m_3)q_2\dot{q}_2 & (m_2 + 4m_3)q_2\dot{q}_1 & 0 \\ -(m_2 + 4m_3)q_2\dot{q}_1 & 0 & 0 \\ 0 & 0 & 0 \end{bmatrix} \\ G(q) &= \begin{bmatrix} 0 \\ 0 \\ -m_3g \end{bmatrix} \end{aligned} \tag{28}$$

Using (5), the states and inputs are $x_{11} = q_1, x_{12} = q_2, x_{13} = q_3, x_{21} = \dot{q}_1, x_{22} = \dot{q}_2, x_{23} = \dot{q}_3, u_1 = \tau_1, u_2 = \tau_2, u_3 = \tau_3$. The desired trajectories are defined as $x_{d,11} = \sin(t), x_{d,12} = 1 + \cos(t), x_{d,13} = 1 + \sin(t), x_{d,21} = \cos(t), x_{d,22} = -\sin(t), x_{d,23} = \cos(t)$. The initial conditions are $x_{11,0} = 0.5$ rad, $x_{12,0} = 2.25$ m, $x_{13,0} = 0.75$ m, $x_{21,0} = 0$ rad/s, $x_{22,0} = 0$ m/s, $x_{23,0} = 0$ m/s.

The dynamic model is (7) and its terms are in (28). Substituting the data of Table 1 in the terms of (9) and (28), it gives

$$\begin{aligned} M(x_1) &= \begin{bmatrix} 0.10785 + 1.7x_{12}^2 & 0 & 0 \\ 0 & 1.7 & 0 \\ 0 & 0 & 0.34 \end{bmatrix} \\ C(x_1, x_2) &= \begin{bmatrix} 1.7x_{12}x_{22} & 1.7x_{12}x_{21} & 0 \\ -1.7x_{12}x_{21} & 0 & 0 \\ 0 & 0 & 0 \end{bmatrix} \\ G(x_1) &= \begin{bmatrix} 0 \\ 0 \\ -3.3354 \end{bmatrix} \end{aligned} \tag{29}$$

Therefore, the terms of the mathematical model (7) are as follows:

$$A = \begin{bmatrix} 0 & 0 & 0 & 1 & 0 & 0 \\ 0 & 0 & 0 & 0 & 1 & 0 \\ 0 & 0 & 0 & 0 & 0 & 1 \\ 0 & 0 & 0 & -\frac{0.9876x_{12}x_{22}}{0.0623+0.9826x_{12}^2} & -\frac{0.9876x_{12}x_{21}}{0.0623+0.9826x_{12}^2} & 0 \\ 0 & 0 & 0 & q_2\dot{q}_1 & 0 & 0 \\ 0 & 0 & 0 & 0 & 0 & 0 \end{bmatrix}$$

$$B = \begin{bmatrix} 0 & 0 & 0 \\ 0 & 0 & 0 \\ 0 & 0 & 0 \\ \frac{0.578}{0.0623+0.9826x_{12}^2} & 0 & 0 \\ 0 & \frac{0.0367+0.578x_{12}^2}{0.0623+0.9826x_{12}^2} & 0 \\ 0 & 0 & \frac{0.1833+2.89x_{12}^2}{0.0623+0.9826x_{12}^2} \end{bmatrix} \tag{30}$$

Considering the terms of Eq. (30) and $R = \text{diag}(0.0002) \in \mathbb{R}^{3 \times 3}$ to solve the Riccati matrix Eq. (21), gives the following adaptive functions for the terms of S : $\dot{S} + Q - SBR^{-1}B^T S + SA + A^T S = 0$ (31)

where:

$$\begin{aligned} \dot{S}_{11} + 1 - \alpha(S_{14})^2 - \beta(S_{15})^2 - \gamma(S_{16})^2 &= 0 \\ \dot{S}_{12} - \alpha S_{24}S_{14} - \beta S_{25}S_{15} - \gamma S_{26}S_{16} &= 0 \\ \dot{S}_{13} - \alpha S_{34}S_{14} - \beta S_{35}S_{15} - \gamma S_{36}S_{16} &= 0 \\ \dot{S}_{14} - \alpha S_{44}S_{14} - \beta S_{45}S_{15} - \gamma S_{46}S_{16} + S_{11} - \delta x_{22}S_{14} \\ + q_2\dot{q}_1S_{15} &= 0 \\ \dot{S}_{15} - \alpha S_{45}S_{14} - \beta S_{55}S_{15} - \gamma S_{56}S_{16} + S_{12} - \delta x_{21}S_{14} &= 0 \\ \dot{S}_{16} - \alpha S_{46}S_{14} - \beta S_{56}S_{15} - \gamma S_{66}S_{16} + S_{13} &= 0 \\ \dot{S}_{22} + 1 - \alpha S_{24}S_{24} - \beta S_{25}S_{25} - \gamma S_{26}S_{26} &= 0 \\ \dot{S}_{23} - \alpha S_{34}S_{24} - \beta S_{35}S_{25} - \gamma S_{36}S_{26} &= 0 \\ \dot{S}_{24} - \alpha S_{44}S_{24} - \beta S_{45}S_{25} - \gamma S_{46}S_{26} + S_{12} - \delta x_{22}S_{24} \\ + x_{12}x_{21}S_{25} &= 0 \\ \dot{S}_{25} - \alpha S_{45}S_{24} - \beta S_{55}S_{25} - \gamma S_{56}S_{26} + S_{22} - \delta\dot{q}_1S_{24} &= 0 \\ \dot{S}_{26} - \alpha S_{46}S_{24} - \beta S_{56}S_{25} - \gamma S_{66}S_{26} + S_{23} &= 0 \\ \dot{S}_{33} + 1 - \alpha S_{34}S_{34} - \beta S_{35}S_{35} - \gamma S_{36}S_{36} &= 0 \\ \dot{S}_{34} - \alpha S_{44}S_{34} - \beta S_{45}S_{35} - \gamma S_{46}S_{36} + S_{13} - \delta x_{22}S_{34} \\ + x_{12}x_{21}S_{35} &= 0 \\ \dot{S}_{35} - \alpha S_{45}S_{34} - \beta S_{55}S_{35} - \gamma S_{56}S_{36} + S_{23} - \delta x_{21}S_{34} &= 0 \\ \dot{S}_{36} - \alpha S_{46}S_{34} - \beta S_{56}S_{35} - \gamma S_{66}S_{36} + S_{33} &= 0 \\ \dot{S}_{44} + 1 - \alpha S_{44}S_{44} - \beta S_{45}S_{45} - \gamma S_{46}S_{46} + 2S_{14} - 2\delta x_{22}S_{44} \\ + 2x_{22}x_{21}S_{45} &= 0 \\ \dot{S}_{45} - \alpha S_{45}S_{44} - \beta S_{55}S_{45} - \gamma S_{56}S_{46} + S_{15} - \delta x_{22}S_{45} \\ + x_{12}x_{21}S_{55} + S_{24} - \delta x_{21}S_{44} &= 0 \end{aligned}$$

$$\begin{aligned} \dot{S}_{46} - \alpha S_{46}S_{44} - \beta S_{56}S_{45} - \gamma S_{66}S_{46} + S_{16} - \delta x_{22}S_{46} \\ + x_{12}x_{21}S_{56} + S_{34} &= 0 \\ \dot{S}_{55} + 1 - \alpha S_{45}S_{45} - \beta S_{55}S_{55} - \gamma S_{56}S_{56} + 2S_{25} - 2\delta x_{21}S_{45} &= 0 \\ \dot{S}_{56} - \alpha S_{46}S_{45} - \beta S_{56}S_{55} - \gamma S_{66}S_{56} + S_{26} - \delta x_{21}S_{46} + S_{35} &= 0 \\ \dot{S}_{66} + 1 - \alpha S_{46}S_{46} - \beta S_{56}S_{56} - \gamma S_{66}S_{66} + 2S_{36} &= 0 \end{aligned} \tag{32}$$

where $\alpha = 5,000 \left(\frac{0.578}{0.0623+0.9826x_{12}^2} \right)^2$, $\beta = 5,000 \left(\frac{0.0367+0.578x_{12}^2}{0.0623+0.9826x_{12}^2} \right)^2$, $\gamma = 5,000 \left(\frac{0.1833+2.89x_{12}^2}{0.0623+0.9826x_{12}^2} \right)^2$, $\delta = \frac{0.9876x_{12}}{0.0623+0.9826x_{12}^2}$.

The control functions for the trajectory tracking of the cylindrical robotic arm are obtained with Eqs. (8) and (17) as follows:

$$\begin{aligned} u &= G(x_1) + \hat{u} \\ u &= G(x_1) - R^{-1}B^T S \tilde{x} \end{aligned} \tag{33}$$

where:

$$\begin{aligned} u_1 &= -5,000 \frac{0.578}{0.0623+0.9826x_{12}^2} [S_{14}(x_{11} - \sin(t)) \\ &+ S_{24}(x_{12} - (1 + \cos(t))) + S_{34}(x_{13} - (1 + \sin(t))) \\ &+ S_{44}(x_{21} - \cos(t)) + S_{45}(x_{22} + \sin(t)) + S_{46}(x_{23} - \cos(t))] \\ u_2 &= -5,000 \frac{0.0367+0.578x_{12}^2}{0.0623+0.9826x_{12}^2} [S_{15}(x_{11} - \sin(t)) \\ &+ S_{25}(x_{12} - (1 + \cos(t))) + S_{35}(x_{13} - (1 + \sin(t))) \\ &+ S_{45}(x_{21} - \cos(t)) + S_{55}(x_{22} + \sin(t)) \\ &+ S_{56}(x_{23} - \cos(t))] \\ u_3 &= -3.3354 - 5,000 \frac{0.1833+2.89x_{12}^2}{0.0623+0.9826x_{12}^2} [S_{16}(x_{11} - \sin(t)) \\ &+ S_{26}(x_{12} - (1 + \cos(t))) \\ &+ S_{36}(x_{13} - (1 + \sin(t))) + S_{46}(x_{21} - \cos(t)) \\ &+ S_{56}(x_{22} + \sin(t)) + S_{66}(x_{23} - \cos(t))] \end{aligned} \tag{34}$$

Remark 5 First, the process starts with the initial condition of x , the adaptive functions (21), (31), (32) are solved at a time to find \dot{S} ; then, the optimal control functions (8), (17), (34) are solved at a time to find u ; later, the robotic arm mathematical model (7), (29), (30) is solved to find \dot{x} . After, the process starts again. The above described process is directly solved using the software Simulink of Matlab.

50, 5, and 0.1 are selected as the proportional, derivative, and integral gains for the PID controller, respectively.

Figure 2 shows the trajectory tracking of the link 1.

Figures 3 and 4 show the trajectory tracking of the links 2 and 3, respectively.

Figures 5, 6, and 7 show the control functions of the links 1, 2, and 3, respectively.

Fig. 2 Trajectory tracking of the link 1

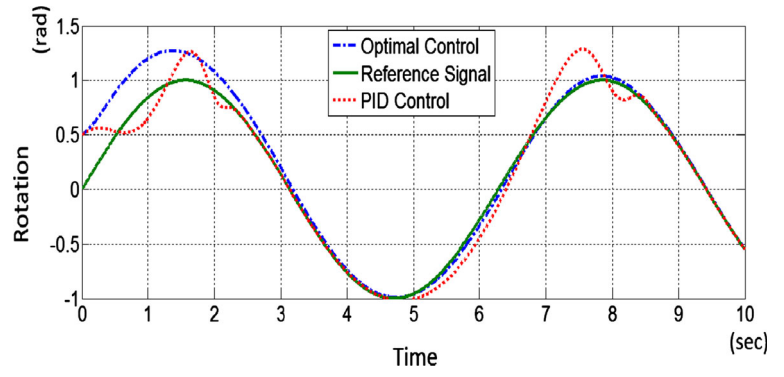

Fig. 3 Trajectory tracking of the link 2

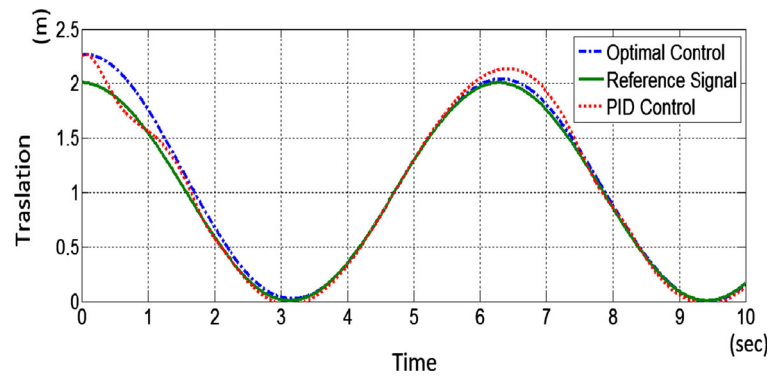

Fig. 4 Trajectory tracking of the link 3

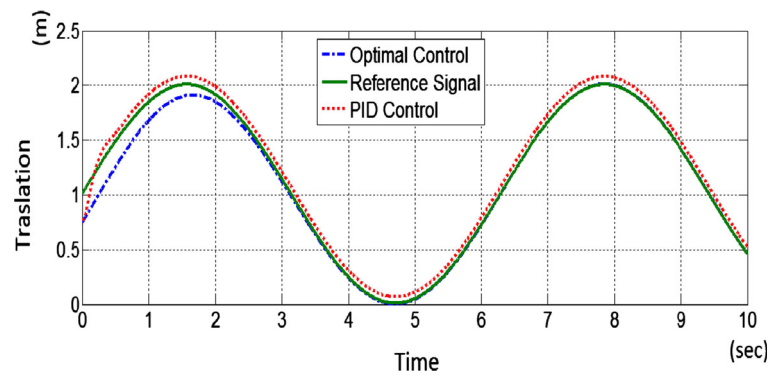

Fig. 5 The control function of the link 1

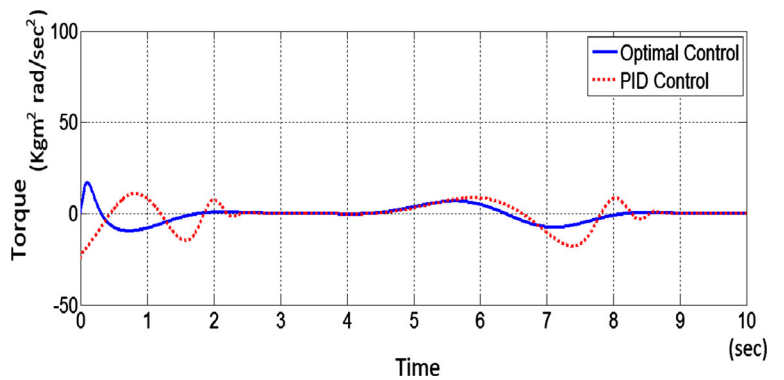
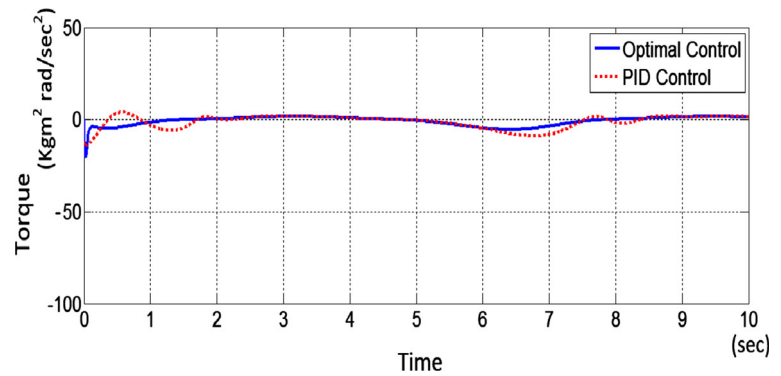
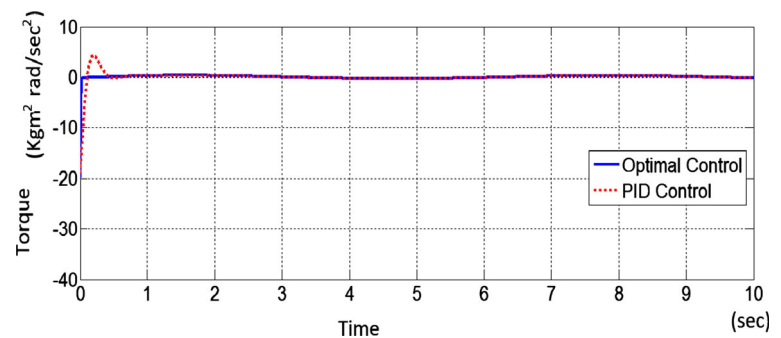

Fig. 6 The control function of the link 2**Fig. 7** The control function of the link 3

From Figs. 2, 3, 4, 5, 6, and 7, it can be seen that the output of the plant follows the desired trajectories for the cylindrical robotic arm; also it is shown that the optimal controller improves the PID control because the signals of the first follow better the references than the signal of the second, and the input functions for the first are smaller than for the second.

6 Conclusion

In this paper, a stable optimal control applied for the trajectory tracking of a cylindrical robotic arm was presented. Some authors proposed optimal controllers and others proposed stable controllers, while this study considered an approach which combined both methods. The proposed algorithm could be used for any of the conventional structures of robotic arms. The simulations showed that the proposed controller improved the PID method being applied for a cylindrical robotic arm. In the future, this control will be proven in experiments, will be applied to other kind of mechatronic systems, and the evolving systems will be applied to approximate some unknown functions of the robotic arm nonlinear model [14, 20–22, 25, 28].

Acknowledgments The authors are grateful to the editors and the reviewers for their valuable comments and insightful suggestions, which helped to improve this research significantly. The authors thank the Secretaría de Investigación y Posgrado, Comisión de Operación y

Fomento de Actividades Académicas del IPN, and Consejo Nacional de Ciencia y Tecnología for their help in this research. The fourth author would like to thank the financial support through a postdoctoral fellowship from Mexican National Council for Science and Technology (CONACYT).

References

- Bachrach J, Beal J, McLurkin J (2010) Composable continuous-space programs for robotic swarms. *Neural Comput Appl* 19:825–847
- Bauerschmitt R, Feuerstein M, Traub J, Schirmbeck EU, Klinker G, Lange R (2007) Optimal port placement and enhanced guidance in robotically assisted cardiac surgery. *Surg Endosc* 21: 684–687
- Biess A, Nagurka M, Flash T (2006) Simulation discrete and rhythmic multi-joint human arm movements by optimization of nonlinear performance indices. *Biol Cybern* 95:31–53
- Celikkanat H, Sahin E (2010) Steering self-organized robot flocks through externally guided individuals. *Neural Comput Appl* 19:849–865
- Chakraborti T, Sengupta A, Konar A, Janarthanan R (2011) Application of swarm intelligence to a twofold optimization scheme for trajectory planning of a robot arm. In: *Lecture notes in computer science, Swarm, Evolutionary and Memetic Computing*, vol 7077. Springer, Heidelberg, pp 89–96
- Chaoui H, Sicard P (2011) Adaptive Lyapunov-based neural network sensorless control of permanent magnet synchronous machines. *Neural Comput Appl* 20:717–727
- Chen C, Inoue Y, Shibata K (2011) Identification of a golf swing robot using soft computing approach. *Neural Comput Appl* 20: 729–740
- Chen CY, Lee CH (2009) Explicit matrix bounds of the solution for the continuous Riccati equation. *ICIC Express Lett* 3(2): 147–152

9. Chiu C-H (2010) Self-tuning output recurrent cerebellar model articulation controller for a wheeled inverted pendulum control. *Neural Comput Appl* 19:1153–1164
10. Christensen DJ, Campbell J, Stoy K (2010) Anatomy-based organization of morphology and control in self-reconfigurable modular robots. *Neural Comput Appl* 19:787–805
11. Eronini I, Umez-Eronini (1998) *System dynamics and control*. Thomson Learning, ISBN: 970-686-041-X
12. García D, Schiehlen W (2012) 3D-simulation of human walking by parameter optimization. *Arch Appl Mech* 82:533–556
13. Ghiasi AR, Alizadeh G, Mirzaei M (2010) Simultaneous design of optimal gait pattern and controller for a bipedal robot. *Multibody Syst Dyn* 23:401–429
14. Jang YM, Lee M, Ozawa S (2011) A real-time personal authentication system based on incremental feature extraction and classification of audiovisual information. *Evol Syst* 2(4): 261–272
15. Jiménez-Lizárraga M, Poznyak A (2006) Near–Nash equilibrium strategies for LQ differential games with inaccurate state information. *Math Probl Eng* 2006(article ID 21509):1–24
16. Jiménez-Lizárraga M, Cruz Jose B (2010) New approach to solve algebraic constraints in linear systems using linear dynamical controllers. *Int J Innov Comput Inf Control* 6(11):4879–4898
17. Jiménez-Lizárraga M, Poznyak A (2012) Necessary conditions for robust stackelberg equilibrium in a multi-model differential game. *Optim Control Appl Methods* 33(5):595–613
18. Koschorreck J, Mombaur K (2012) Modeling and optimal control of human platform diving with somersaults and twists. *Optim Eng* 13:29–56
19. Lee W-P, Yang T-H (2011) Combining GRN modeling and demonstration-based programming for robot control. *Neural Comput Appl* 20:909–921
20. Leite D, Ballini R, Costa P, Gomide F (2012) Evolving fuzzy granular modeling from nonstationary fuzzy data streams. *Evol Syst*
21. Lemos A, Caminhas W, Gomide F (2011) Fuzzy evolving linear regression trees. *Evol Syst* 2(1):1–14
22. Leng G, Zeng XJ, Keane JA (2012) An improved approach of self-organizing fuzzy neural network based on similarity measures. *Evol Syst*
23. Lewis FL, Syrmos VL (1995) *Optimal control*, 2nd edn. Wiley, New York, ISBN: 0-471-03378-2
24. Lewis FL, Dawson DM, Abdallah CT (2004) *Control of robot manipulators. Theory and Practice*, 2nd edn. Marcel Dekker, Inc., New York, ISBN: 0-8247-4072-6
25. Rong H-J, Sundararajan N, Huang G-B, Zhao G-S (2011) Extended sequential adaptive fuzzy inference system for classification problems. *Evol Syst* 2(2):71–82
26. Rubio JJ, García E, Pacheco J (2011) Trajectory planning and collisions detector for robotic arms. *Neural Comput Appl* 21(8): 2105–2114
27. Rubio JJ, Torres C, Rivera R, Hernández CA (2011) Comparison of four mathematical models for braking of a motorcycle. *IEEE Latin Am Trans* 9(5):630–637
28. Rubio JJ, Vazquez DM, Pacheco J (2010) Backpropagation to train an evolving radial basis function neural network. *Evol Syst* 1(3):173–180
29. Spong MW, Hutchinson S, Vidyasagar M (2006) *Robot modeling and control*. Wiley, New York, ISBN: 13-978-0-471-64990-8
30. Villaverde I, Graña M (2011) Neuro-evolutionary mobile robot egomotion estimation with a 3D ToF camera. *Neural Comput Appl* 20:345–354
31. Wu Y, Sun F, Zheng J, Song Q (2010) A robust training algorithm of discrete-time MIMO RNN and application in fault tolerant control of robotic system. *Neural Comput Appl* 19:1013–1027
32. Wu H, Sun F, Sun Z, Wu L (2004) Optimal trajectory planning of a flexible dual-arm space robot with vibration reduction. *J Intell Robot Syst* 40:147–163
33. Yin Y, Hosoe S, Zhiwei Luo (2007) A mixed logic dynamical modeling formulation and optimal control of intelligent robots. *Optim Eng* 8:321–340