

# Constrained Linear State Feedback Controller for a Low-Power Gas Turbine Model

N. A. Elkhateeb<sup>1\*</sup>, R. I. Badr<sup>2</sup>, A. A. Abouelsoud<sup>2</sup>

<sup>1</sup>Electronics and Communications Dept., Institute of aviation and engineering technology, Giza, Egypt.

<sup>2</sup>Electronics and Communications Dept., Faculty of Engineering, Cairo University, Giza, Egypt.

\*<sup>1</sup>nasrantar@gmail.com, <sup>2</sup>ragiabadr@yahoo.com, <sup>2</sup>aali711964@yahoo.com

**Abstract** -This paper introduces a well-developed and systematic optimization approach to find a constrained linear state feedback control law to a linearized version of a low-power gas turbine model. In the first part of the paper, the nonlinear model is presented and linearized around the operating point, and then the linearized model is discretized with suitable sampling time to apply the proposed technique. Necessary and sufficient conditions for the existence of a solution to the constrained problem are presented. Secondly, the constrained problem is adopted in a linear programming technique to find the control law which guarantees the positive invariance conditions of constraints polytope while the input control remains bounded under prefixed values along the trajectory of the closed loop system. Furthermore, both discrete time and nonlinear model are simulated under the obtained feedback control law and the results fulfill the predefined state constraints without violating the control bounds.

**Keywords**- Linear state feedback; nonlinear models; gas turbines; polyhedral constraints; positive invariance.

## I. INTRODUCTION

This paper deals with the problem of designing a stabilizing constrained state feedback controller for a linearized version of a low-power gas turbine while the control input not violates the prefixed control bounds along the trajectory of the closed loop system. The importance of the constrained control law comes from the practical behavior of control systems. Control law design in real systems faces some challenges, due to differences between the behavior of the practical system and the system model used. These differences may add constraints on the system model (i.e. state constraints, input constraints and parametric uncertainties) narrow the distance between the system model and the actual system behavior. This may occur, for example, when dealing with input saturation, the linearity assumption is satisfactory only in specific regions of the state space or when the violation of state constraints may cause irreversible damage to some components of the system. Hence, the presence of such constraints may dramatically affect the performance of the overall system so that it is necessary to integrate the constraints directly in the design process. Ignoring these constraints in the design of the controllers may lead to non-practical system conditions, losing control performances, producing limit cycles, and even to the instability of the closed loop system as discussed in [1].

Bitsoris [2,3] and Blanchini [4] have found that

designing state feedback controller for discrete time linear systems under state and input control polyhedral constraints, basically, depends on the positive invariance theory where the state feedback control law guarantees that a given polytope in the state space is positively invariant while the input control remains bounded under prefixed values. The eigen structure approach has been used to design state feedback law for discrete-time Linear Time Invariant (LTI) constrained systems subject to actuator constraints as discussed by Castelan [5], Abouelsoud [6], Tarbouriech [7] and Vassilaki, Hennes, and Bitsoris [8]. Also, the problem of existence of positively invariant sets for discrete-time LTI systems has studied in [9]. Basilio, Milani, and Carvalhos [10], have studied regulator problem under polyhedral constraints. Different techniques are suggested Wei, Yuan, and Hong [11], and Blanchini [12] to solve and study systems under constraints in presences of uncertainties and disturbances. Recently, the set invariant approach has been used to solve the constrained system where a controlled invariant polyhedral sets for linear discrete-time descriptor system subject to state and control constraints and persistent disturbances have been constructed in [13]. Programming techniques have also been suggested by Benvenuti, and Farina [14] to find an appropriate control law for constrained systems with no uncertainty. Furthermore, new programming technique has been presented in [15, 16] to design a stabilizing controller for constrained linear discrete time uncertain systems and find the largest uncertainty accompanied with such control law.

Gas turbine is constrained nonlinear mechanical system used in transportation such as, aircrafts, cars as well as power systems which they are the main power generators. Many control approaches applied on gas turbine based on linear control. Mu, and Liu [17], has designed advanced PID control for aircraft gas turbine engines. In Perez [18], state-space based linear controllers have been used. In addition to linear quadratic Gaussian control with loop transfer recovery (LQG/LTR) has been suggested in [19] and robust control system design have also been performed for gas turbines as discussed in [20]. Moreover, different types of nonlinear control approaches for gas turbine control have been suggested. Model predictive control has been presented in [21, 22]. On the other hand, intelligent control was used in solving this case (i.e. neural networks, genetic algorithms and fuzzy control as discussed in [23, 24].

This paper is organized as follows: In section 2 a nonlinear state space model for the gas turbine system descriptions are given. The positive invariance approach and

its preliminarily definitions are given in section 3. The linear programming technique and an appropriate objective function are presented in section 4. In section 5, the constrained state feedback law is applied to the discrete time gas turbine model. The simulation of the discrete time closed loop shows the ability of the proposed controller in satisfying the constraints of the model. The simulations of the nonlinear gas turbine model in the presence of the controller are given. The results obtained from the simulations of the nonlinear system prove that good performance of the gas turbine can be achieved by using the suggested constrained state feedback controller. Finally, section 6 presents the conclusion and an insight to future work and nomenclature of the gas turbine model is given at the end of the paper.

## II. GAS TURBINE MODEL

### A. System Description:

The main parts of a gas turbine include the inlet duct, compressor, combustion chamber, turbine and nozzle or gas-deflector. The main parts of the gas turbine are shown in Fig.1.

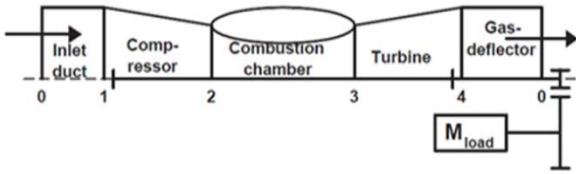

Fig.1 the main parts of the gas turbine

### B. Modeling Assumptions:

The gas turbine model proposed in [25, 26] is suitable for control proposes under the following modeling general assumptions.

- Constant physic-chemical properties are assumed in each main part of the gas turbine, such as specific heat at constant pressure and at constant volume, specific gas constant and adiabatic exponent.
- Heat loss (heat transmission, heat conduction, heat radiation) is neglected.

### C. Dynamic Model Equations

The dynamic model of the gas turbine is presented in [25] However, appendix A contains the nomenclature of the turbine model.

$$\frac{dm_{Comb}}{dt} = \dot{m}_C + \dot{m}_{fuel} - \dot{m}_T \quad (1)$$

$$\frac{dp_3^{tot}}{dt} = \frac{p_3^{tot}}{T_3^{tot} m_{Comb} C_v} (\dot{m}_C C_p T_2^{tot} - \dot{m}_T C_p T_3^{tot} + Q_f \eta_{Comb} \dot{m}_{fuel}) \quad (2)$$

$$\frac{dn}{dt} = \frac{1}{4\pi^2 \theta n} \left( \dot{m}_T C_p (T_3^{tot} - T_4^{tot}) \eta_{mech} - \dot{m}_C C_p (T_2^{tot} - T_1^{tot}) - 2\pi \frac{3}{50} n M_{load} \right) \quad (3)$$

The following equations describe the total temperature after the compressor ( $T_2^{tot}$ ), the total temperature before turbine ( $T_3^{tot}$ ) and the total temperature after the turbine ( $T_4^{tot}$ ). In addition the compressor mass flow rate ( $\dot{m}_C$ ) and the turbine mass flow rate ( $\dot{m}_T$ ) respectively.

### D. Constitutive (Algebraic) Equations

1. The total temperature after the compressor is found by using the isentropic efficiency  $\eta_C$  in the following manner:

$$T_2^{tot} = T_1^{tot} \left( 1 + \frac{1}{\eta_C} \left( \left( \frac{p_3^{tot}}{p_1^{tot}} \right)^\gamma - 1 \right) \right) \quad (4)$$

2. The total temperature after combustor is found using the ideal gas equation which is used for the combustion chamber:

$$T_3^{tot} = \frac{p_3^{tot} V_{Comb}}{m_{Comb} C_v} \quad (5)$$

3. The total temperature after the turbine is found similarly by using the isentropic efficiency  $\eta_T$

$$T_4^{tot} = T_3^{tot} \left( 1 - \eta_T \left( 1 - \left( \frac{p_1^{tot}}{p_3^{tot} \sigma_I \sigma_N} \right)^\gamma \right) \right) \quad (6)$$

4. The following two equations describe the mass flow rate of the compressor and the turbine.

$$\dot{m}_C = \beta A_1 \frac{p_1^{tot}}{\sqrt{T_1^{tot}}} \left( a_1 \frac{n}{\sqrt{\frac{T_1^{tot}}{T_o}}} \frac{p_3^{tot}}{p_1^{tot} \sigma_{Comb}} + a_2 \frac{n}{\sqrt{\frac{T_1^{tot}}{T_o}}} + a_3 \frac{p_3^{tot}}{p_1^{tot} \sigma_{Comb}} + a_4 \right) \quad (7)$$

$$\dot{m}_T = \beta A_3 \frac{p_3^{tot}}{\sqrt{\frac{p_3^{tot} V_{Comb}}{m_{Comb} R}}} \left( b_1 \frac{\zeta n}{\sqrt{\frac{p_3^{tot} V_{Comb}}{m_{Comb} R}}} \frac{p_3^{tot} \sigma_I \sigma_N}{p_1^{tot}} + b_2 \frac{\zeta n}{\sqrt{\frac{p_3^{tot} V_{Comb}}{m_{Comb} R}}} + b_3 \frac{p_3^{tot} \sigma_I \sigma_N}{p_1^{tot}} + b_4 \right) \quad (8)$$

The model constants can be found in Table II in Appendix A.

1. The dynamic model of the gas turbine is valid within the following operating domain:

$$m_{Comb \min} \leq m_{Comb} \leq m_{Comb \max} \quad (9)$$

$$p_{3 \min}^{tot} \leq p_3^{tot} \leq p_{3 \max}^{tot} \quad (10)$$

$$n_{\min} \leq n \leq n_{\max} \quad (11)$$

Where the typical values of the constraints as follow:

$$m_{Comb\ min} = 0.00305\ kg, \quad m_{Comb\ max} = 0.00835\ kg,$$

$$p_{3\ min}^{tot} = 154837\ Pa, \quad p_{3\ max}^{tot} = 325637\ Pa, \quad n_{min} = 650\ \frac{1}{s},$$

and  $n_{max} = 833.333\ \frac{1}{s}$

Avoid the saturation of the actuator so that the control input  $\dot{m}_{fuel}$  is bounded:

$$0 \leq \dot{m}_{fuel} \leq 0.03\ kg/s \quad (12)$$

### E. Transformation to Dimensionless Form

The equations of the gas turbine model equations (1) to (8) are transformed into the dimensionless form by using the standard transformation variables in Table I. This transformation is applied to normalize the gas turbine variables through dividing them by the normalizing variables given in the following table.

Table I: The standard quantities to transform the model variables to its dimensionless form.

Reference quantity	Reference quantity
Temperature : $T_r = T_1$	Mass : $m_r = \frac{P_r V_{Comb}}{R T_r}$
Pressure : $P_r = P_1$	Mass flow rate : $\dot{m}_r = \rho_r a A_1$
Density : $\rho_r = \frac{P_r}{R T_r}$	Time : $t_r = \frac{m_r}{\dot{m}_r}$
Velocity : $a_r = \sqrt{\gamma R T_r}$	Dimensionless time : $\tau = \frac{t}{t_r}$
Speed : $n_r = \frac{n}{n_o}$	

The dimensionless equations of the gas turbine model will be written w.r.t the normalized variables given in Table I.

a. From (1), let  $z_1 = \frac{m_{Comb}}{m_r}$  then  $m_{Comb} = z_1 m_r$ , and

$$w = \frac{\dot{m}_{fuel}}{\dot{m}_r}$$

$$\frac{dz_1}{d\tau} = \frac{\dot{m}_C}{\dot{m}_r} + \frac{\dot{m}_{fuel}}{\dot{m}_r} - \frac{\dot{m}_T}{\dot{m}_r} = \dot{m}_{C_o} + w - \dot{m}_{T_o} \quad (13)$$

b. From (2), let  $z_2 = \frac{p_3^{tot}}{p_r}$  then  $p_3^{tot} = z_2 p_r$

$$\frac{dz_2}{d\tau} = \frac{z_2}{T_{3_o} z_1 C_v} \left( \frac{\dot{m}_C}{\dot{m}_r} C_p T_{2_o} - \frac{\dot{m}_T}{\dot{m}_r} C_p T_{3_o} + Q_f \eta_{Comb} \frac{\dot{m}_{fuel}}{\dot{m}_r} \right)$$

$$= \frac{z_2}{T_{3_o} z_1 C_v} \left( \dot{m}_{C_o} C_p T_{2_o} - \dot{m}_{T_o} C_p T_{3_o} + Q_f \eta_{Comb} w \right) \quad (14)$$

c. From (3), let  $z_3 = \frac{n}{n_o}$  then  $n = z_3 n_o$

$$\frac{dz_3}{d\tau} = \frac{T_r m_r}{4\pi^2 \Theta n_o^2 n_r} \left( \dot{m}_{T_o} C_p (T_{3_o} - T_{4_o}) \eta_{mech} - \dot{m}_{C_o} C_p (T_{2_o} - 1) - 2\pi \frac{3 n_o n_r M_{load}}{50 T_r \dot{m}_r} \right) \quad (15)$$

Also the Constitutive equations transformed to the dimensionless form as follows:

$$T_{2_o}^{tot} = \left( 1 + \frac{1}{\eta_C} \left( (p_{3_o}^{tot})^{\frac{\gamma-1}{\gamma}} - 1 \right) \right) \quad (16)$$

$$T_{3_o}^{tot} = \frac{p_{3_o}^{tot}}{m_{Comb\ o}} \quad (17)$$

$$T_{4_o}^{tot} = T_{3_o}^{tot} \left( 1 - \eta_T \left( 1 - (p_{3_o}^{tot} \sigma_I \sigma_N)^{\frac{\gamma}{\gamma-1}} \right) \right) \quad (18)$$

$$\dot{m}_{C_o} = \beta \sqrt{\frac{R}{\gamma}} \left( a_1 \frac{n_o n_r}{\sqrt{\frac{T_r}{T_o}}} \frac{p_{3_o}^{tot}}{\sigma_{Comb}} + a_2 \frac{n_o n_r}{\sqrt{\frac{T_r}{T_o}}} + a_3 \frac{p_{3_o}^{tot}}{\sigma_{Comb}} + a_4 \right) \quad (19)$$

$$\dot{m}_{T_o} = \frac{\beta A_3 m_{Comb\ o}}{A_1} \sqrt{\frac{R}{\gamma T_r}} \left( b_1 \tau n_o n_r p_{3_o}^{tot} \sigma_I \sigma_N + b_2 \tau n_o n_r \right.$$

$$\left. + (b_3 p_{3_o}^{tot} \sigma_I \sigma_N + b_4) \sqrt{\frac{p_{3_o}^{tot} T_r}{m_{Comb\ o}}} \right) \quad (20)$$

The model state and input constraints (9) to (12) are also transformed to its dimensionless form around the obtained operating point

$$z_{min} \leq z \leq z_{max} \quad (21)$$

The transformed input fuel rates

$$w_{min} \leq w \leq w_{max} \quad (22)$$

### F. Linearization

The obtained nonlinear state space model described by equation (13) to (14) is linearized around the operating point  $z_o$  in the matrix form as follows:

$$\frac{dz(\tau)}{d\tau} = f(z_1, z_2, z_3, w) \quad (23)$$

Using the first-order Taylor expansion of (23) leads to the following

$$\dot{z}(t) \cong f(z_o, w_o) + A z(t) + B w(t) \quad (24)$$

where  $z = (z_1, z_2, z_3)^T$

Note, the  $(z_o, w_o)$  are the equilibrium values of the nonlinear system (23) such that  $f(z_o, w_o) = 0$ , then the linearized continuous time state space model is based on first order derivative i.e.

$$A := \left. \frac{\partial f(z, w)}{\partial z} \right|_{z=z_o, w=w_o} \quad (25.a)$$

$$B := \left. \frac{\partial f(z, w)}{\partial w} \right|_{z=z_o, w=w_o} \quad (25.b)$$

To ensure the state constraint polytope containing the origin (i.e.  $x_{min} < 0 < x_{max}$ ), assume that:

Let  $x = z - z_o$  and  $u = w - w_o$ , the state and input control variables are shifted around operating point

$$\dot{x}(t) = A x(t) + B u(t) \quad (26)$$

State constraints (21) and input control (22) will be

$$x_{min} \leq x \leq x_{max} \quad (27)$$

$$u_{min} \leq u(t) \leq u_{max} \quad (28)$$

The linearized gas turbine model (25) is discretized with a sampling time  $T_s$  and the discrete time model has  $\Phi$  and  $\Gamma$  as the discrete time matrices i.e.

$$x(k + 1) = \Phi x(k) + \Gamma u(k), \quad (29)$$

where  $\Phi = e^{AT_s}$ , and  $\Gamma = \int_0^{T_s} e^{A\tau} B d\tau$

Now, given a polyhedral set  $\mathcal{P}$  containing the origin, the problem is to find a linear stabilizing controller for the linearized version gas turbine model (28)

$$u(k) = F^T x(k), \text{ for every } k \geq 0 \quad (30)$$

Such that state constraint polytope (27) is positively invariant with respect to the motion of the closed-loop system (31) while the control does not violate the input constraint (28). Moreover, the closed loop system is asymptotically stable.

$$x(k + 1) = (\Phi + \Gamma F^T) x(k) \quad (31)$$

In order to proceed in the proposed technique, preliminarily definitions are presented in the following section.

### III. PRELIMINARY DEFINITION

Definition 1:

Controlled invariant set: The set  $\Omega$  is called a controlled invariant set of the nominal system

$$x(k + 1) = \Phi x(k) + \Gamma u(k) \quad (32)$$

If and only if there exists a feedback control law  $u(k) = F^T x(k)$  such that  $\Omega$  is an invariant set of  $x(k + 1) = (\Phi + \Gamma F^T)x(k)$

Definition 2:

Substochastic matrix: A non-negative matrix  $S \in R^{n \times m}$  is called substochastic matrix

$$\begin{aligned} & \text{If } s_{ij} \geq 0, \quad i = 1, \dots, n \text{ and } j = 1, \dots, m, \\ & \sum_i s_{ij} \leq 1, \quad j = 1, \dots, m \end{aligned} \quad (33)$$

The following definition illustrates the term convex combination.

Definition 3:

Convex polytope: The polytope  $\mathcal{P}$ , with  $0 \in \mathcal{P}$ , consisting of all convex combinations of the vectors  $(v_1, \dots, v_M)$  will be denoted as  $\text{conv}(v_1, \dots, v_M)$ , i.e.

$$\begin{aligned} \mathcal{P} &= \text{conv}(v_1, \dots, v_M) \\ &:= \{p \in R^n \mid p = \sum_{i=1}^M \alpha_i v_i, \sum_{i=1}^M \alpha_i = 1, \alpha_i \geq 0, i \\ &= 1, 2, \dots, M\}. \end{aligned} \quad (34)$$

The following Theorem.1 is presented in [14] gives the necessary and sufficient condition for a given polytope  $\mathcal{P} = \text{conv}(P)$ , to be positive invariant with respect to the motion of the closed loop system (31) in terms of its vertices. Moreover, Theorem .2 is given by Seneta [27] and it gives the relation between the eigenvalues of the closed loop

system and the positive invariance condition of the polytope  $\mathcal{P}$ .

Theorem 1:[14]

The polytope  $\mathcal{P} = \text{conv}(P)$ , with  $0 \in \mathcal{P}$ , is positively invariant with regard to the motions of the closed loop system  $x(k + 1) = (\Phi + \Gamma F^T)x(k)$ , if and only if there is exist a sub-stochastic matrix  $S$  such that

$$(\Phi + \Gamma F^T)P = PS \quad (35)$$

Theorem 2: [27]

If there exists a substochastic matrix  $S$  which satisfies the following equality  $(\Phi + \Gamma F^T)P = PS$ , then the spectral radii of  $(\Phi + \Gamma F^T)$  is a subset of that of  $S$ .

The following Theorem .3 guarantees the existence of a positive invariant polytope for asymptotically stable system and Lemma .1 gives the positive invariant in terms of polytope vertices.

Theorem 3: [14]

The existence of asymptotically stabilizing feedback control law for the nominal system (29) implies the existence of a positively invariant polytope  $\mathcal{P}$  with respect to the motions of the closed-loop system (31).

Proofs are presented in [14].

Lemma 1: [1]

The set  $\mathcal{P}$  is positively invariant with respect to the motion of the closed loop system (31) if and only if it is positively invariant with respect to the motion of system (31) at vertices  $v_p(i), i = 1, 2, \dots, M$ , of the set  $\mathcal{P}$ .

Proofs are given in [1].

### IV. THE OPTIMIZATION TECHNIQUE

The invariant property of the polytope  $\mathcal{P}$  is shown by Theorem 1 and lead to the set of the linear inequalities (35) in the unknown variables  $s_{ij}$  and  $F^T$ . The set of inequalities give more than one solution, hence, an optimization technique is used by Benvenuti and Farina in [14] to select the best one by using an objective function that improve the closed loop stability. In this context, Gantmacher [28] found that the state feedback control law that makes the state polytope  $\mathcal{P}$  positive invariant satisfies the following criteria: the set of the eigenvalues of the closed loop  $(\Phi + \Gamma F^T)$  is a subset of the eigenvalues of  $S$ . An optimization technique is used to minimize the spectral radius of the closed loop matrix  $(\Phi + \Gamma F^T)$  by selecting an objective function approximates the spectral radius of the substochastic matrix  $S$ .

From the definition of the spectral radii of any non-negative matrix  $S \in R^{n \times n}$  is  $\mu(S) = \max\{|\lambda_1|, |\lambda_2|, \dots, |\lambda_n|\}$ , where  $(\lambda_1, \lambda_2, \dots, \lambda_n)$  and  $(\lambda_i \geq 0)$  are the eigen values of the matrix  $S$ . Using the sum of all elements of matrix  $S$  as an objective function is proposed as discussed in [29]. That choice depends on the well-known fact  $\mu(S) \leq \sum_{ij} s_{ij}$  given by Seneta [27]. However, the suggested objective function hereby is modified to be the

trace of the matrix  $S$ . Note that, the suggested objective function is linear in the unknown variables  $s_{ij}$  which reduce the optimization technique to linear one. The linearized discrete time system (29) for the gas turbine model has a feasible state feedback control law  $u(k) = F^T x(k)$ , under the polyhedral constraints (27) while the control does not violate the constraints (28), if the following linear programming problem has a feasible solution

$$\min \text{tr}(S)$$

subject to

$$(\Phi + \Gamma F^T) P = P S \quad (36.a)$$

$$u_{\min} \leq F^T v_p^i \leq u_{\max}, \quad i = 1, \dots, h \quad (36.b)$$

$$s_{ij} \geq 0, \quad i, j = 1, \dots, h \quad (36.c)$$

$$\sum_i s_{ij} \leq 1, \quad j = 1, \dots, h \quad (36.d)$$

Where  $h$  is the number of vertices of the polytope  $\mathcal{P}$ , condition (36.a) comes from the positive invariance Theorem 1. Conditions (36.b) come from input control constraints (27), and conditions (36.c) and (36.d) imply that the matrix  $S$  is a non-negative substochastic matrix.

Benvenuti and Farina [14, 29], have found that positive invariance does not guarantee asymptotic stability of the uncertain system; however the proposed linear programming approach can achieve asymptotic stability of the closed-loop system if the optimization constraints (36.d) strictly hold. To illustrate this point, the spectral radius  $\rho(S)$  of a non-negative matrix  $S \in R_+^{n \times n}$  must satisfy the following inequality:

$$\rho(S) \leq \max(\sum_{i=1}^n s_{i1}, \sum_{i=1}^n s_{i2}, \dots, \dots, \sum_{i=1}^n s_{in}) \quad (37)$$

Combining (37) and (36.d) yields  $\sum_{i=1}^n s_{ij} \leq 1$ , which imply that  $\rho(S) < 1$ . Consequently, from the results of Theorem 2, the condition of the asymptotic stability  $\rho(A + BF^T) < 1$  can be achieved. Moreover, the asymptotic stability is mainly related to the objective function, thus if a good choice of the optimization function is well selected, then it would improve asymptotic stability.

## V. RESULTS AND DISCUSSION

In this section, the proposed technique is applied to both nonlinear model and the linearized discrete time version. The MATLAB Optimization Toolbox is used in the simulations and numerical results of this work.

### A. Simulation Procedure

The obtained results for both systems shows the efficiency of the developed controller to stabilize the system and ensures the positive invariance of the state constraints while input fuel rate remains bounded to avoid the saturation of the actuator along the trajectory of the closed loop system. The simulation steps can be summarized as follow:

**Step 1:** Select the inlet condition then find the operating point of the nonlinear system by solving  $f(z_1, z_2, z_3, w) = 0$ .

The applied minimal and maximal parameter and disturbance values are given in [25, 26]. Atypical inlet condition point has been selected to be:

Inlet temperature  $T_1 = 288.16 \text{ K}$   
 Total inlet pressure  $P_1 = 1.01325 \times 10^5 \text{ Pa}$   
 The required torque  $M_{load} = 75 \text{ Nm}$   
 Rotational speed  $n = 750 \text{ (1/sec)}$

**Step 2:** Shift the system variables around the operating point to build the polytope  $\mathcal{P}$ . The static operating point is obtained by finding the static solution of the nonlinear equations (13-15).

$$z^T(0) = [0.76639, 2.2059, 1] \quad (38)$$

Consequently, the obtained input fuel rate is  $w(0) = 0.003996$ . Hence, the dynamic system has the following physical operating domain:

$$0.4387 \leq z_1 \leq 1.2009 \quad (a)$$

$$1.5281 \leq z_2 \leq 3.2138 \quad (b)$$

$$0.8667 \leq z_3 \leq 1.1111 \quad (39)$$

The mass fuel rate is bounded:

$$0 \leq w(t) \leq 0.0123 \quad (40)$$

The origin of the model variables  $z(t)$  and input control  $w(t)$  are shifted around the operating point  $z^T(0) = (0.76639 \ 2.2059 \ 1)$ , hence, both the state and input constraints will be as follow:

$$-0.3277 \leq x_1(k) \leq 0.4345 \quad (a)$$

$$-0.6778 \leq x_2(k) \leq 1.0079 \quad (b)$$

$$-0.1333 \leq x_3(k) \leq 0.1111 \quad (c) \quad (41)$$

And the control input fuel rate is shifted to:

$$-0.0040 \leq u(k) \leq 0.0083 \quad (42)$$

Hence, the state constraints polytope  $\mathcal{P}$  created from the set of constraints shown in (39) i.e.

**Step 3:** linearize the nonlinear model around the operating point to compute  $A$  and  $B$  matrices

By substituting in the first-order Taylor differential matrices (25) with the operating point  $z^T(0) = (0.76639 \ 2.2059 \ 1)$ , leads to the linearized continuous time matrices will be as follows i.e.

$$A = \begin{pmatrix} -0.1576 & -0.2438 & 0.9155 \\ 1.0197 & -1.2017 & 1.9574 \\ -0.0287 & 0.0418 & -0.0933 \end{pmatrix}, B = \begin{pmatrix} 1.0 \\ 163.87 \\ 0 \end{pmatrix} \quad (42)$$

The obtained continuous time linear state space model (42) is stable around the operating point and the open loop system eigen values are real stable poles:

$$\lambda_1 = -0.8874, \lambda_2 = -0.5512 \text{ and } \lambda_3 = -0.0140.$$

**Step 4:** discretize the continuous time system using suitable sampling time  $T_s$  and compute discrete time matrices  $\Phi$  and  $\Gamma$ .

The model (42) is discretized with a sampling period  $T_s = 2.5$  sec. And the discrete time matrices of the linearized model (29) form

$$\Phi = \begin{pmatrix} 0.4327 & -0.0844 & 1.0205 \\ 0.4603 & 0.0137 & 2.0889 \\ -0.0034 & 0.0312 & 0.8801 \end{pmatrix}, \Gamma = \begin{pmatrix} -36.5639 \\ 118.7188 \\ 9.5908 \end{pmatrix} \quad (43)$$

**Step 5:** the positive invariance technique is applied to find the state feedback control law  $F^T$  by solving the optimization problem (36).

$$u(k) = (-0.00048134 \quad -0.00304685 \quad -0.0052841619)x(k) \quad (44)$$

The obtained state feedback guarantees the stability of the overall discrete time system where the closed loop eigen values are found to be:  $\lambda_1 = -0.3631$ ,  $\lambda_2 = 0.4891$  and  $\lambda_3 = 0.8057$ .

**Step 6:** stabilizing both discrete time and nonlinear systems by using the obtained feedback control law then simulate them for the selected initial condition. Both the discrete model and the nonlinear model are simulated under the obtained state feedback controller (44) and the initial conditions are chosen to be the vertices of the state constraints polytope to achieve the results of lemma.1

**B. Results for Discrete Time Model**

For more illustration, Fig 2 illustrates the response of the closed loop when applying the control law (44) on the discrete-time system model (43) when the initial state starting from

$$x^T(0) = (-0.3277 \quad -0.6778 \quad -0.1333).$$

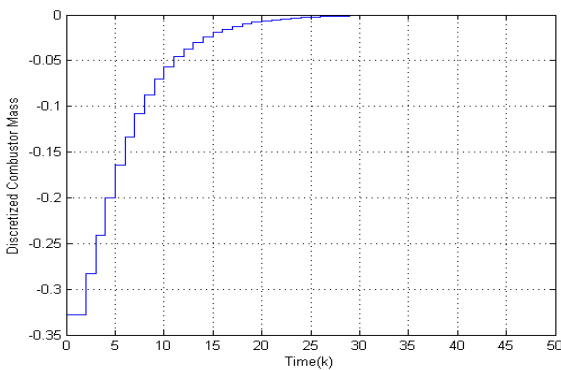

Fig .2-a the normalized mass in combustor chamber  $x_1(k)$

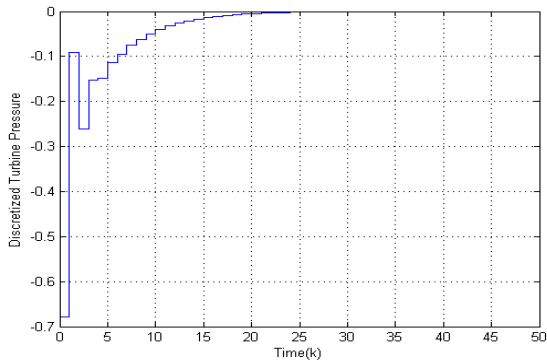

Fig .2-b the normalized inlet turbine pressure  $x_2(k)$

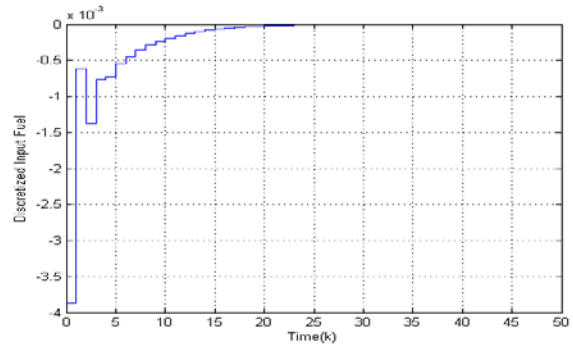

Fig .2-c the normalized rotational speed  $x_3(k)$

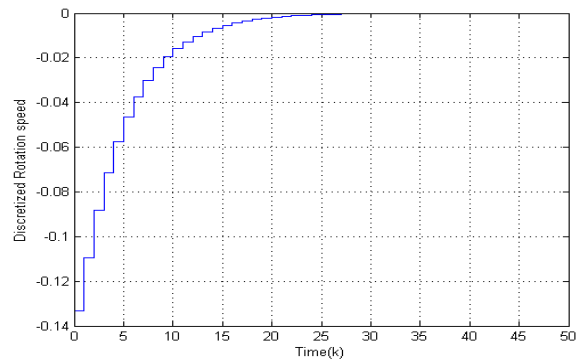

Fig .2.d the fuel mass rate  $u(k) = F^T x(k)$

The proposed state feedback controller fulfills the stability of the origin while the input control is bounded under the prefixed control bounds (42). It is obvious also that, similar results and figures can be obtained when the proposed state feedback controller is applied to any vertex of the state constraints polytope  $\mathcal{P}$ .

**C. Results for the Nonlinear Model**

This section presents the simulation and numerical results based on the state feedback controller (44) when applied on the nonlinear gas turbine model (13-15). From equation (23); there exists a constant value for the control input  $u(k)$  where the first-order Taylor expansion of the nonlinear system takes the following form:

$$\dot{z}(t) = A(z - z_o) + B(w - w_o) + H.O.T \quad (45)$$

The closed loop system of the discrete time system

$$x(k + 1) = (\Phi + \Gamma F^T)x(k) + H.O.T \quad (46)$$

Then the control input  $u(k)$  for the linearized system:

$$u(k) = F^T x(k) \Rightarrow \tilde{w}(k) - w_o = F^T (z(k) - z_o) \\ \tilde{w}(k) = w_o + F^T (z - z_o) \Rightarrow \\ \tilde{w}(k) = F^T z(k) + v_o = u(k) + v_o \quad (47.a)$$

Where  $v_o = w_o - F^T z_o$  is the static value of the control input  $u(k)$  for the initial conditions. The steady state value of the normalized mass fuel rate was  $w_o = 0.0039962$ , then the static value of the control input for the initial condition in **Step 1**.

$$v_o = 0.0039962 - F^T \begin{pmatrix} 0.76639 \\ 2.2059 \\ 1 \end{pmatrix} = 0.01567718 \quad (47.b)$$

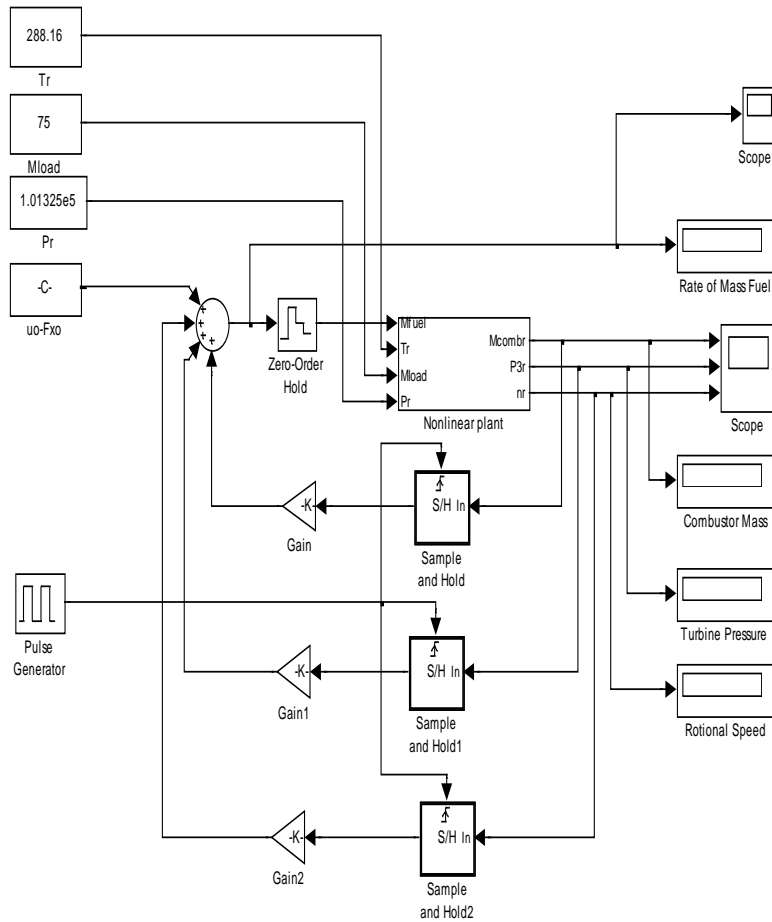

Fig .3 closed loop block diagram of the nonlinear system by using MATLAB Simulink

Figure 4, shows the continuous time version of the nonlinear system variables( $t$ ), and the input control $w(t)$ . Moreover, the results depicted in Fig.4, show the efficiency of the proposed control when simulating the nonlinear system under the obtained control law. The system state trajectories starting from boundary of the state constraints and the results prove that the state trajectories remain within the operating along the trajectories of the closed loop nonlinear system without violating the input control limits. Moreover, similar results can be obtained when the initial conditions are changed to any point lying in the operating range (39) of the nonlinear gas turbine model.

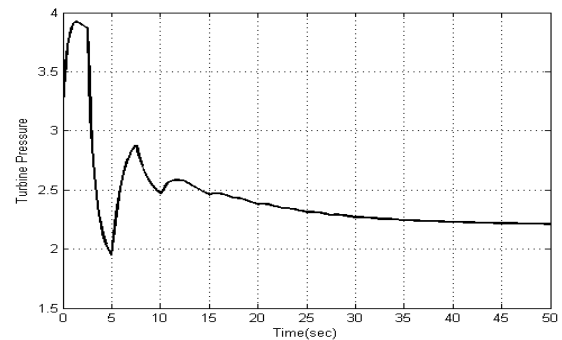

Fig.4-b turbine total inlet pressure $z_2(t)$

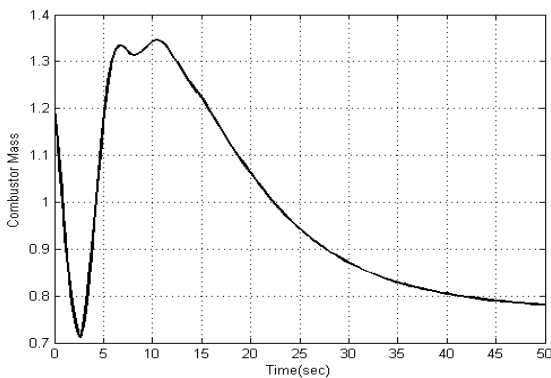

Fig .4-a mass in combustion chamber $z_1(t)$

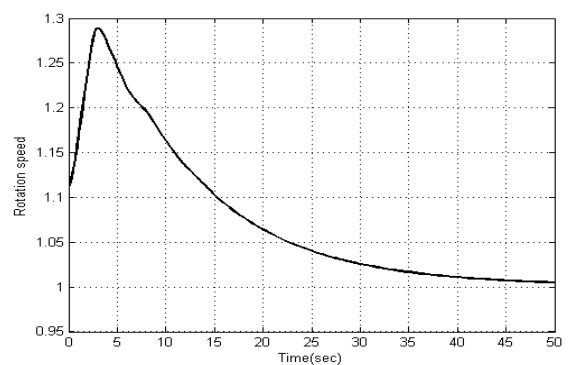

Fig .4-c rotational speed  $z_3(t)$



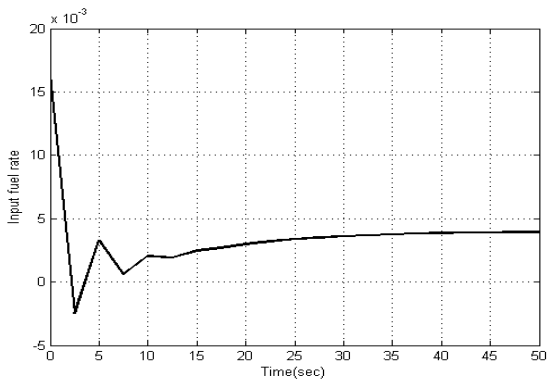

Fig. 4-d mass fuel rate  $w = \frac{\dot{m}_{fuel}}{\dot{m}_r} \cong \tilde{w}(k) = F^T z(t) + v_o$ .

## VI. CONCLUSION

A linear state feedback controller for a linearized discrete time of a low-power gas turbine version is designed under state constraints while the mass fuel rate is bounded under prefixed fuel limits along the closed loop trajectories. The main idea focuses on how to make the system constraints polytope in the state space positively invariant without violating the input control bounds. The nonlinear model of the gas turbine is linearized around the operating point and the obtained continuous time is discretized with a suitable sampling time period. The positive invariance property of the constraints polytope leads to set of linear inequalities can be solved by using an optimization technique. A linear programming approach is adopted and an objective function is proposed that guarantees the positive invariance of the state constraints polytope and improves the eigen values of the closed loop system.

The proposed technique is applied to the discrete time model and fulfills the required constraints without violating the input control bounds. Moreover, the obtained state feedback controller is applied to the nonlinear system and proved its efficiency when used in stabilizing the practical nonlinear system. The simulations of the nonlinear system show good results in controlling the plant fulfill the required performance. Operating conditions are sources for uncertainties and disturbances in the gas turbine system. Future work is dedicated towards design robust constrained state feedback controller to stabilize gas turbine system under a wide range of operating conditions and improve asymptotic stability of the plant.

## REFERENCES

- F. Mesquine, A. Benlemkdem, A. Benzaouia, "Robust constrained regulator problem for linear uncertain systems, *Journal of Dynamical and Control Systems*", Vol. 10, No. 4, 2004, pp. 527-544, 2004.
- G Bitsoris, "Positively invariant polyhedral sets for discrete-time linear systems", *International Journal of Control*, Vol.47, No. 6, pp. 1713-1726, 1988.
- G. Bitsoris, "Positively invariant polyhedral sets for continuous-time linear systems", *Control theory and advanced technology*, Vol.7, No.3, pp. 407-427, 1991.
- F. Blanchini, "Set Invariance in Control", *Automatica*, Vol. 35, pp. 1747-1767, 1999.
- E.B. Castelan, "On invariant polyhedral of constraints time linear systems", *IEEE, AC*, Vol.38, No.11, pp. 1680-1685, 1993.
- A.A. Abouelsoud, "Global stabilization of linear time invariant system subject to state and control constraints", *The Mediterranean journal of measurement and control*, Vol.3, No.4, pp. 113-119, 2007.
- S.Tarbouriech, E.B. Castelan, "An eigenstructure assignment approaches for constrained linear continuous-time singular systems", *Systems & Control Letters*, Vol.24, pp. 333-343, 1995.
- M. Vassilaki, J.C. Hennet, G. Bitsoris, "Feedback control of linear discrete-time systems under state and control Constraints", *International Journal of Control*, Vol. 47, pp. 1727-1735, 1988.
- P.O. Gutman, M. Cwinkel, "An algorithm to find maximal state constraint sets for discrete-time linear dynamical systems with bounded controls and states", *IEEE Transaction. AC*, Vol. 32, pp. 251-254, 1987.
- E. A. Basilio, Milani, A. N. Carvalhos, "Robust linear regulator design for discrete-time systems under polyhedral constraints", *Automatica*, Vol.31, No-10, pp. 1489-1493, 1995.
- F.G. Wei, L.Z. Yuan, C. Hong, "Feedback control of discrete linear switching systems with bounded state and control input in the presence of disturbances", *ACTA AUTOMATICA SINICA*, Vol.36, No.8, pp. 1115-1121, 2010.
- F. Blanchini, "Constrained control for uncertain linear systems", *Journal of optimization theory and applications*, Vol.71, NO.3, pp. 465-484, 1991.
- J. Araujo, C. Dorea, "Controlled invariant polyhedral sets for constrained discrete-time descriptor systems" *IFIP International Federation for Information Processing*, pp. 385-392, 2010.
- L. Benvenuti, L. Farina, "Linear programming approach to constrained feedback control", *International journal of systems science*, Vol.33, No.1, pp. 45-53, 2002.
- N. Elkhateeb, R. Badr, A. Abouelsoud, "Enlarging parameter uncertainties for a class of constrained Discrete-Time linear systems" *The Mediterranean Journal of Measurement and Control*, Vol. 6, No. 4, pp. 167-173, 2010.
- Elkhateeb, N.A., Badr, R.I, and Abouelsoud, A.A, "Robust controller for a class of constrained discrete-time systems with enlarged parameter uncertainties", submitted for publication in: *The Mediterranean Journal of Measurement and Control*, Vol. 7, No. 3, pp. 250-259, 2011.
- J. Mu, D. Rees, GP. Liu, "Advanced controller design for aircraft gas turbine engines", *Control Engineering Practice*, Vol.13, pp. 1001-1015, 2005.
- RA. Perez, "Model reference control of a gas turbine engine", In *Proceedings of the Institution of Mechanical Engineers - Part G: Journal of Aerospace Engineering*, pp. 291-296, 1996.
- M. Athans, P. Kapasouros, E. Kappos, H. Spang, "Linear-quadratic Gaussian with loop-transfer recovery methodology for the F-100 engine", *IEEE Journal of Guidance and Control* Vol.9, No.1, pp. 45-52, 1986.
- AE.Ariffin, N. Munro, "Robust control analysis of a gas-turbine aero engine", *IEEE Transactions on Control Systems Technology*, pp. 178-188, 1997.



B. Brunell, R. Bitmead, A. Connolly, "Nonlinear model predictive control of an aircraft gas turbine engine", Proc. of the 41st IEEE Conference on Decision and Control, Las Vegas, Nevada USA 2002.

F. Jurado, J. Carpio, "Improving distribution system stability by predictive control of gas turbines", Energy Conversion and Management, Vol. 47, pp. 2961–2973, 2006.

A. Chipperfield, B. Bica, P. Fleming, "Fuzzy scheduling control of a gas turbine aero-engine: a multi-objective approach", IEEE Tr. on Industrial Electronics, Vol.49, pp.536–548, 2005.

S. Lin, L. Yeh, "Intelligent control of the F-100 turbofan engine for full flight envelope operation", International Journal of Turbo & Jet-Engines, Vol. 22, pp. 201–213, 2005.

P. Ailer, I. Santa, G. Szederkényi, KM. Hangos, "Nonlinear model-building of a low-power gas turbine", Periodical polytechnic a Ser. Transportation Engineering, Vol.29, No.1, pp.117–135, 2001.

P. Ailer, G. Szederkényi, KM. Hangos, "Model-based nonlinear control of a low-power gas turbine", In Proceedings of the 15th IFAC World Congress on Automatic Control, Camacho EF, Basanez L, de la Puente JA (eds). Elsevier Science, 2002.

E. Seneta, "Non-negative matrices and markov chain", New-York: Springer, USA, 1981.

F. Gantmacher, "The theory of matrices", New York: Chelsea, 1959.

L. Benvenuti, L. Farina, "Invariant polytopes of linear systems", IMA Journal of Mathematical control and Information, Vol. 15, 1998, pp. 233-240.

- 0 inlet duct inlet
- 1 compressor inlet
- 2 compressor outlet
- 3 turbine inlet
- 4 turbine outlet
- C refers to compressor
- Comb refers to combustion chamber
- Comb refers to combustion
- Fuel refers to fuel
- I refers to inlet duct
- Mech mechanical
- N refers to gas deflector
- P refers to constant pressure
- T refers to turbine
- $v$  refers to constant volume
- H. O. T Higher Order Terms
- Superscripts
- Tot refers to a total quantity
- $o$  refers to dimensionless quantity

APPENDIX A

I. NOMENCLATURE OF THE TURBINE MODEL

Variables/Constants Subscripts

- Aarea [m]
- M torque [Nm]
- $Q_f$  lower thermal value of fuel [J/kg]
- R specific gas constant [J/(kg K)]
- T temperature [K]
- U internal energy [J]
- V volume [m<sup>3</sup>]
- C specific heat [J/(kg K)]
- M mass [kg]
- N rotational speed [1/s]
- P pressure [Pa]
- T time [s]
- $a_1, a_2$  coefficients of  $\dot{m}_c$  [s]
- $a_3, a_4$  coefficients of  $\dot{m}_c$  [-]
- $b_i, i = 1, \dots, 4$  coefficient of  $\dot{m}_T$  [s]
- $\beta$  specific par. of air & gas [ $\sqrt{Ks/m}$ ]
- $\eta$  efficiency [-]
- $\Theta$  inertial moment [kg m<sup>2</sup>]
- $\gamma$  adiabatic exponent [-]
- P the matrix where  $\mathcal{P} = conv(P)$
- S substochastic matrix
- $\mu$  spectral radius of a matrix
- $\mathcal{P}$  the polytope of the state constraints
- $\dot{m}$  mass flow rate [kg/s]

Table II: States, input, output and inlet condition variables

Notation	Variable name/Units
$n$	rotational speed [1/s]
$M_{load}$	load torque [Nm]
$\dot{m}_{fuel}$	mass flow rate of fuel [kg/s]
$T_4^{tot}$	turbine outlet total temperature [K]
$m_{comb}$	mass in combustion chamber [kg]
$p_1^{tot}$	compressor inlet total pressure [Pa]
$p_3^{tot}$	turbine total inlet pressure [Pa]
$T_1^{tot}$	compressor inlet total temperature [K]

Table III: Constants of the simplified model of the DEUTZ T216 type turbine [25]

Not.	Value (Units)	Not.	Value (Units)
R	287 (J/kg K)	$\beta$	0.0404184 ( $\sqrt{Ks/m}$ )
$C_p$	1004.5 (J/kg K)	$C_v$	717.5 (J/kg K)
$\gamma$	1.4	$\zeta$	0.028071 ( $\sqrt{Ks}$ )
$Q_f$	42.8 (MJ/kg)	$T_o$	288.16 (K)
$A_1$	0.0058687 (m <sup>2</sup> )	$A_1$	0.0117056 (m <sup>2</sup> )
$\sigma_N$	0.96687	$\sigma_I$	0.98879
$\sigma_{Comb}$	0.93739		
$\eta_c$	0.67585	$\eta_T$	0.85677
$\eta_{comb}$	0.79161	$\eta_{mech}$	0.9801
$\Theta$	.0004 (kg m <sup>2</sup> )	$V_{Comb}$	0.005675 (m <sup>3</sup> )
$a_1$	0.00035319 (s)	$a_2$	0.0011097 (s)
$a_3$	-0.4611	$a_4$	0.16635
$b_1$	-0.033728	$b_2$	0.004458
$b_3$	0.048847	$b_4$	0.15542

## BIOGRAPHIES



**N.A. Elkhateeb** obtained his B.Sc. and M.Sc. degree with honors from the Electronics and Communications Department, Faculty of Engineering, Cairo University in 2006, 2011 respectively. He is currently a Ph.D. student at Faculty of Engineering, Electronics and Communications Department, Cairo University.

His research interests are advanced programming techniques, evolutionary programming techniques, constrained systems, and nonlinear systems.



**R. I. Badr** obtained her B.Sc. degree with distinction and honors in 1979 from the Electronics and Communications Department, Faculty of Engineering, Cairo University. She got her M.Sc. degree in Systems and Control Engineering in 1982. She earned her Ph.D. in Systems and Control Engineering in 1987 from Cairo University. In 1987 she was appointed as an assistant professor in the Electronics and Communications Department, Faculty of Engineering, Cairo University. She is currently a Professor at the same department and her research areas include Robust Constrained Control, Neuro-Fuzzy Control, and Adaptive-Non-Linear Control.



**Ahmed Ali Abouelsoud** is a professor of automatic control at the electronics and communications engineering department, Cairo University, was born in Cairo, Egypt in 1964. He received the B.Sc., in electrical engineering in 1986 (distinction with honor), the M.Sc., in control engineering in 1990, and the PhD in control engineering in 1995, all from Cairo University, Egypt. He is a member of IEEE automatic control society and has been a visiting assistant professor at Washington State University, USA in 2001. Dr Ahmed Joined Sultan Qaboos University, Oman in 2008-2009, and Taibah University, KSA in 2011-2012. He published more than 30 journal papers in automatic control, and robotics. His research interests are in nonlinear and adaptive control and distributed control systems..