



Comparative Study of Speed Control of D.C. Motor Using PI, IP, and Fuzzy Controller

Prof. Aziz Ahmed¹, Yogesh Mohan², Aasha Chauhan³, Pradeep Sharma⁴

H.O.D, EEE Dept, AFSET College, Faridabad, Haryana, India ¹

Student, EEE Dept, AFSET College, Faridabad, Haryana, India ²

Assistant Prof., EEE Dept, Lingaya's University, Faridabad, Haryana, India ³

Assistant Prof., EEE Dept, PPIMT, Hisar, Haryana, India ⁴

Abstract: The paper presents the simulation results obtained on a dc motor control system with a basic Fuzzy logic controller (FLC). From the last decade, the need for electric driven vehicle has risen rapidly due to the global warming problem. The traditional Proportional-Integral (P - I) controller, which has been widely used for the speed control of dc motor drives, has been compared with the relatively new Integral-Proportional (I-P) controller which first discussed in the year of 1978. P-I controller is used to control the speed of DC Motor. A model is developed and simulated using MATLAB/SIMULINK. However, the P-I controller has some disadvantages such as: the high starting overshoot, sensitivity to controller gains and sluggish response due to sudden disturbance. So, the relatively new Integral-Proportional (I-P) controller is proposed to overcome the disadvantages of the P-I controller. This paper presents some improvements in this important field of industries. The simulation and the experimental results indicate the superiority of (I-P) controller over (P-I) controller. The proposed controller results in reduced oscillations around the set point which are present in system with a basic fuzzy logic controller.

Keywords: Fuzzy logic controller (FLC), Integral- Proportional (I-P) controller, Proportional-Integral (P-I) controller, Speed control, DC Motor drive.

I. INTRODUCTION

Conventional dc motors are highly efficient and their characteristics make them suitable as servomotor. However, its needs a commutator and brushes which are subject to wear and required maintenance. The functions of commutator and brushes were implemented by solid-state switches that can realize maintenance-free motors. These motors are now known as brushless dc motors. Brushless dc motors are widely used in various applications. Two examples of them are electric vehicle and industrial machinery.

Fuzzy logic controller (FLC) which is presented by Zadeh in 1965, is a new controller [1]. Besides that, FLC is more efficient from the other controller such as P-I controller. The comparison between them is needed to compare what the controller is efficient [2]. The reason why conventional controller low efficiency such as P-I controller because the overshoot is too high from the set point and it may takes delay time to get constant and sluggish response due to sudden change in load torque and the sensitivity to controller gains K_i and K_p [3].

II. MATHEMATICAL MODELLING

The P-I controller has a proportional as well as an integral term in the forward path, the block diagram with a P-I

controller for a dc motor drive is shown in Fig. 1. The integral controller has the property of making the steady-state error zero for a step change, although a P-I controller makes the steady-state error zero, it may take a considerable amount of time to accomplish this. Fig. 2 shows I-P controller along with a dc motor drive, where the proportional term is moved to the feedback path and it acts like feedback compensation. The analysis in S- domain is discussed in this section to study the transient and the steady-state behaviour for both controllers.

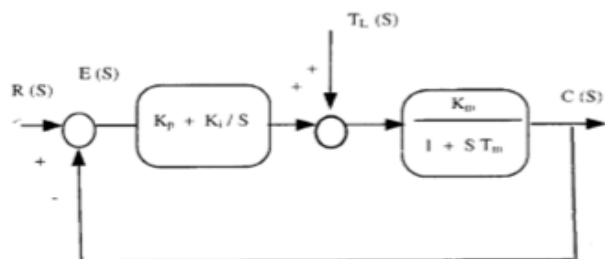

Fig 1. Block diagram with P-I controller

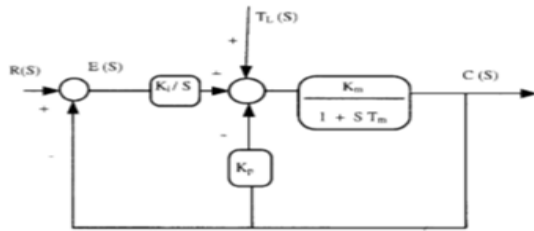

Fig 2. Block diagram with I-P controller

A. P - I Controller

The closed loop transfer function between the output C(S) and the input R(S) is given in (1).

$$\frac{C(S)}{R(S)} = \frac{K_m (S K_p + K_i)}{T_m S^2 + (1 + K_m K_p) S + K_m K_i} \quad (1)$$

Where K_i and K_p , are the integral and the proportional gains of P-I or I-P controller, T_m , is the mechanical time constant of motor, and K_m , is the motor gain constant.

The transfer function between the output C(S) and the load torque disturbance $T_L(S)$ is given in (2).

$$\frac{C(S)}{T_L(S)} = \frac{S (1 + S T_m)}{T_m K_p S^2 + (K_m + T_m K_i + K_p) S + K_i} \quad (2)$$

I - P Controller

The closed loop transfer function between the output C (S) and the input R (S) is given in (3).

$$\frac{C(S)}{R(S)} = \frac{K_i K_m}{T_m S^2 + (1 + K_m K_p) S + K_m K_i} \quad (3)$$

From (1) and (3), P-I and I-P controllers have the same characteristic equations, and it can be seen that the zero introduced by the P-I controller is absent in the case of the I-P controller. Therefore the overshoot in the speed, for a step change in the input reference R (S) is expected to be smaller for the I-P control.

III. SPEED CONTROL SYSTEM USING A BASIC FUZZY LOGIC CONTROLLER

The block diagram of the dc motor control system with a basic FLC is shown in Fig. 3. The basic FLC consists of the following four blocks [6]:

- Fuzzifier which converts input data (error and error rate) into suitable linguistic values.
- Knowledge base which consists of a data base with necessary linguistic definitions (rule set).

- Decision making logic which is used to decide what control action should be taken.
 - Defuzzifier which produces a non-fuzzy control action that represents the membership function of an inferred fuzzy control action.
- Defuzzification is done using the Center-of-gravity method in which the inferred (numerical) value of the

$$u = \frac{\sum m_i T_i}{\sum T_i}$$

where m_i are the singletons and T_i are the corresponding degree of fulfilment.

The output of the controller is the change in motor voltage ΔV_c . The linguistic variables for the input and output set are Negative Large (NL), Negative Small (NS), Zero (Z), Positive Small (PS), and Positive Large (PL) as shown in Fig. 4. The rule base used in the design of the FLC is shown in Fig. 5. The location of the singletons are the centers of gravity of the triangular sets that are -3, -1, 0, +1, t_3 for NL, NS, Z, PS, PL respectively.

The state space model of the dc motor used in the simulation is given by:

$$\begin{bmatrix} \dot{i}_a \\ \dot{\omega}_m \\ \dot{\theta}_m \end{bmatrix} = \begin{bmatrix} -R_a / L_a & -K_v / L_a & 0 \\ K_v / J_m & B_m / J_m & 0 \\ 0 & 1 & 0 \end{bmatrix} \begin{bmatrix} i_a \\ \omega_m \\ \theta_m \end{bmatrix} + \begin{bmatrix} 1 / L_a \\ 0 \\ 0 \end{bmatrix} v_c$$

State space model

where all the variables are well known. The damping ratio ζ of a second order system is expressed in terms of the maximum overshoot M , as

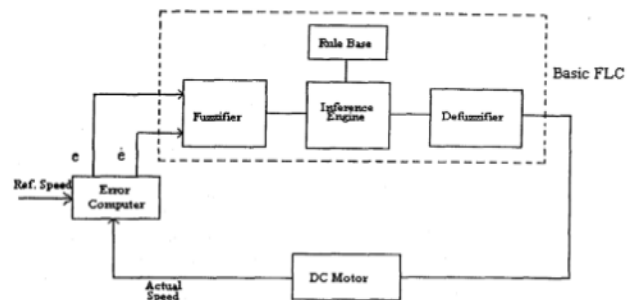
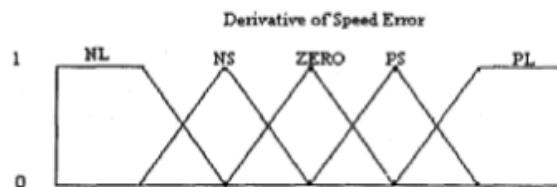

Fig 3. Fig Basic Function of Fuzzy Logic Controller



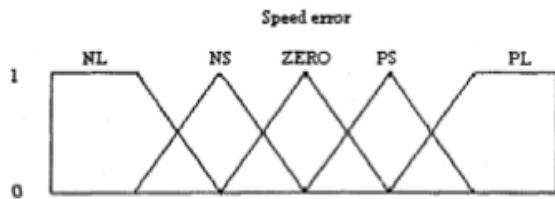

Fig 4. Set of linguistic variables

e	NL	NS	ZERO	PS	PL
PL		PL		NL	NL
PS	PS	ZERO	NS	NL	NL
ZERO	PL	PS	ZERO	NS	NL
NS	PL	PL	PS	ZERO	NS
NL	PL	PL		PS	

Fig 5. Rule base used in the design of the FLC

$$\delta = \frac{(\ln M_p)^2}{\pi^2 + (\ln M_p)^2}$$

IV. SIMULATION AND RESULTS

A. P-I Controller

The PI controller is used to control the speed and torque of an induction motor. PI controller gets one input. The actual speed and reference speed are compared and the error of the speed is given as input to PI controller. Based on the proportional gain value and the integral gain value, the PI controller regulates an output which is given to the inverter triggering switch depending on the load variation.

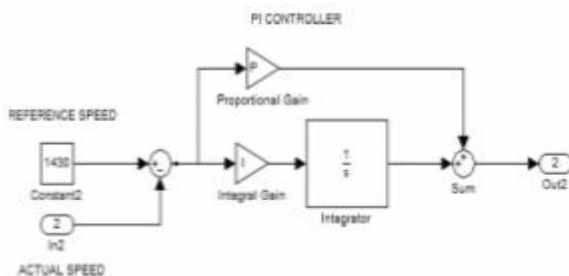

Fig 6. Basic model of P-I controller

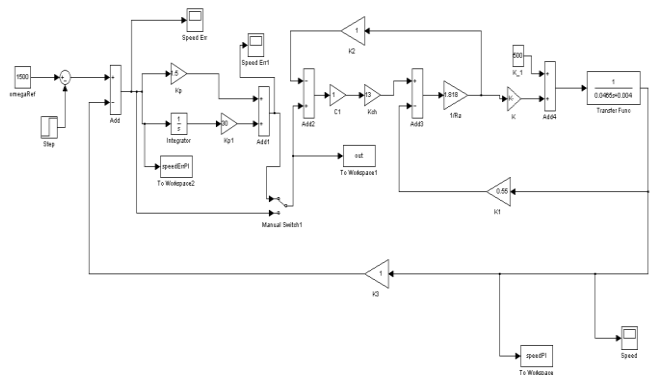

Fig 7. PI controller

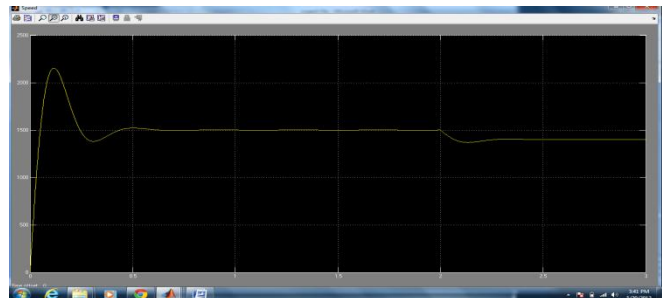

Fig 8. Simulation Result Of PI Simulink Model

B. Simulink Model of IP Controller

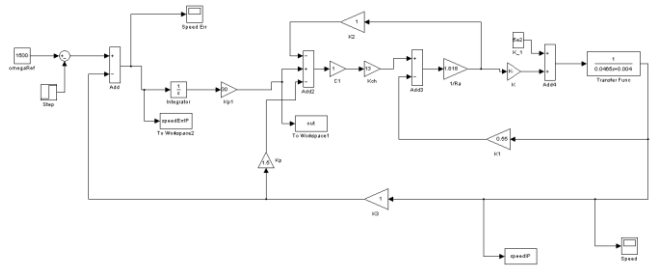

Fig 9. I-P controller

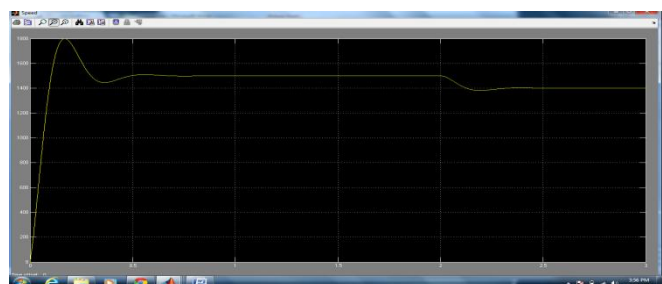

Fig 8. Simulation Result Of IP Simulink Model

C. Fuzzy Logic Controller

Fuzzy logic control (FLC) is a control algorithm based on a linguistic control strategy which tries to account the human's



knowledge about how to control a system without requiring a mathematical model [6,7]. The approach of the basic structure of the fuzzy logic controller system is illustrated in Fig 9.

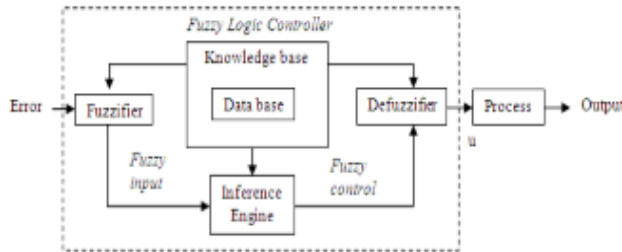

Fig 9. Structure of Fuzzy Logic Controller

Input and output are non-fuzzy values and the basic configuration of FLC is featured in Fig10. In the system presented in this study, Mamdani type of fuzzy logic is used for speed controller. Inputs for Fuzzy Logic controller are the speed error (e) and change of speed error. Speed error is calculated with comparison between reference speed, ω_{ref} and the actual speed, ω_{act} .

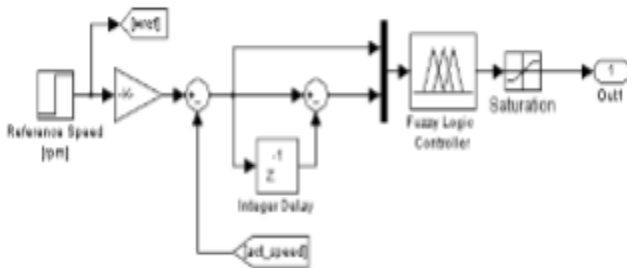

Fig 10. Block Diagram of FLC

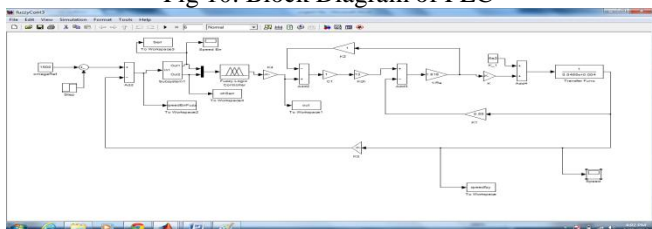

Fig 11. Simulink model of FUZZY Controller

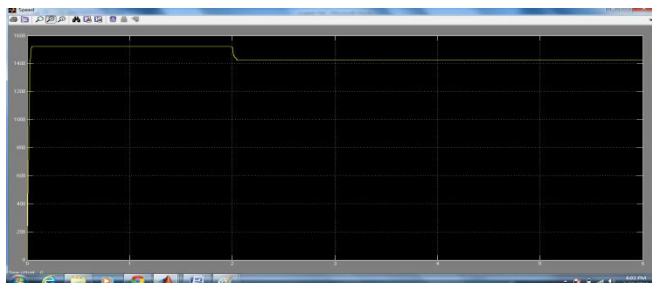

Fig 12. Simulation Result Of FUZZY Simulink Model

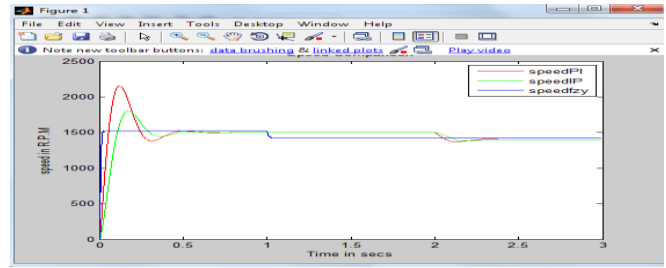

Fig 13. Comparative Speed scope

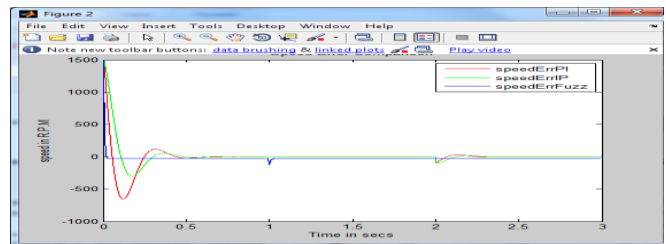

Fig 14. Comparative Speed Error Scope

V. CONCLUSION

From simulation results, it was shown that PI controller maintained the steady state accuracy while the fuzzy controller performed well in the case of sufficiently large reference input changes with shorter settling time. The IP controller has integrated both fuzzy controller and PI controller. During the large speed error, the fuzzy controller will be selected by switch. The PI controller will be selected to maintain the high steady-state accuracy.

The project is intended to demonstrate, the successful application of I-P controller to a phase-controlled converter dc separately excited motor-generator system. I-P controller's performance was compared with that of conventional P-I system. I-P controllers show some important advantages: the overshoot in speed is limited, thus the starting current overshoot is reduced. Also, using the suitable coefficient gains, I-P controllers offer good load recovery characteristics. Moreover, the simulation and experimental studies clearly indicate the superior performance of I-P controller, because it is inherently adaptive in nature. From the above derivation I-P controllers can replace P-I for the speed control of dc motor drives.

The simulation results obtained on a dc motor speed control system using a fuzzy logic controller are presented in the paper. The system uses a basic FLC as well as an improved FLC in which an error interpreter is included. It is seen that the step response with error interpreter has a smaller rise time and a reduced overshoot.

REFERENCES

- [1] J. Lee, "On methods of improving performance of PI-type fuzzy logic controllers," IEEE Trans. on Fuzzy Systems, Vol. 1, pp. 298 - 301, Nov. 1993.



- [2] S. Bolognani and M. Zigliotto, "Fuzzy logic control of a switched reluctance motor drive," IEEE Trans. on Industry Applications, Vol. 12, pp. 1063- 1068, Sept./Oct. 1996.
- [3] C.C. Lee, "Fuzzy logic in control system: Fuzzy Logic Controller- Part, I and II," IEEE Trans. on Systems Man and Cybernetics, Vol. 20, pp. 404 - 435,1990.
- [4] Controller for dc-dc converter," IEEE Trans. on Power Electronics, Vol. 12, pp. 79 - 86, Jan. 1997.
- [5] Fuzzy logic controller for dcldc converter: Design, computer simulation, and experimental evaluation," IEEE Trans. on Power Electronics, Vol. 11, pp. 24 - 31, Jan. 1996.
- [6] Hamid Berenji, "Fuzzy logic controllers," Sterling Software, Artificial Intelligence Research Branch, NASA, Ames research Center, 1991.
- [7] Devendra Rai, Brushless DC Motor Simulink Simulator, Department of Electronics and Communication Engineering, National Institute of Technology Karnataka, Surathkal 575 025, INDIA
- [8] Yodyium Tipsuwan and Mo-Yuen Chow, "Fuzzy Logic microcontroller implementation for DC motor speed control", IEEE Trans. Power Electronics, Vol. 11, No.3, pp 1271-1276, 1999.
- [9] Hanns, Michael. "A Nearly Strict Fuzzy Arithmetic for Solving Problems with Uncertainties." Online posting. 14 Dec. 2002.
- [10] Devendra Rai, Brushless DC Motor Simulink Simulator, Department of Electronics and Communication Engineering, National Institute of Technology Karnataka, Surathkal 575 025, INDIA
- [11] "Tour Of Fuzzy Logic Functions." Wolfram Reasearch, Inc. 28 Nov. 2002.
- [12] Espinosa J.J. and Vandewalle J., "Predictive Control Using Fuzzy Models", Advances in Soft Computing - Engineering Design and Manufacturing (Eds.), R. Roy, Springer – London, ISBN 1-852- 33062-7, 1998
- [13] M. C. Robles, "Simulation and power quality analysis of grid-tied inverters for distributed generation," UMI, 2003, pp.8-15.
- [14] Wei Ke-xin, Wang Shui-ming, "Modeling and Simulation of Three-Phase Voltage Source PWM Rectifier," International conference on advanced computer theory and engineering, pp. 982-986, 2008.
- [15] Shen Chuan-Wen, Liu Wei, Lu Qiang, Zhang Jing-jing, "Research on PWM converter based on decoupling strategy," Power electronics, vol. 40, no. 2, pp. 28-32, April 2006.
- [16] K. M. Passino, Stephen Yurkovich, Fuzzy Control, ADDSISON-WESLEY, 1997, pp. 10
- [17] Zeng guang-qi, Hu Jun-an, Wang Dong, Liu Chun-ling, "fuzzy control theory and engineering application," HUST Press, 2006, pp. 86.
- [18] Zhen yuyu, "Space-vector PWM with TMS320C24x/F24x using hardware and software determined switching patens," SPRA524, pp.4-5, Texas Instruments, March 1999