

Improved Configurations for Dc to Dc Buck and Boost Converters

M.Jahanmahin, A.Hajihosseini, E.Afjei, M.mesbah

Department of Electrical Engineering Shahid Beheshti University, Tehran, Iran

Jahan_mahin@yahoo.com

hajihosseini@yahoo.com

Afjei@yahoo.com

m_mesbah65@yahoo.com

Abstract— dc to dc converters are used to change the input voltage level to a desired output voltage level less (Buck converter) or more (Boost converter) than the input voltage magnitude. This paper proposes a novel method for increasing output power by utilizing two storage elements as well as reducing the output ripple voltage for Buck and Boost converters. In this improved converters, two inductors are used for feeding the load by two independent switches. One inductor charges up by the source voltage while another inductor is discharging its energy into the load during this time. The output power production is almost doubled while the ripple voltage is reduced by a factor of two when compared to a conventional dc to dc converter. This paper provides the analysis, simulation, experimental results as well as the comparison with conventional Buck and Boost converters.

Keywords—component; dc-dc Buck converter; Boost converter; ripple voltage.

I. INTRODUCTION

In several power conversion applications, it is required to convert a constant dc voltage source to a variable output dc voltage. This is performed by dc-dc converters [1]-[3]. In other words, the dc-dc converter is similar to transformer in the ac systems. These converters are used in several applications such as regulated DC power supplies, renewable energy systems, electrical vehicles, cranes, distributed generation systems, and power factor Correction process [4]-[8]. In past decade, several studies have been done about reducing the output voltage ripple of dc-dc converters [9]-[15]. Changing structure of the converter using new topology can improve the operation of the converter. A good design requires special attentions to many circuit parameters such as voltage ripple, maximum current of each element, power losses, voltage stress, and etc. These parameters usually have tradeoff in such way that improving of one parameter might have a big effect on another parameter. For example, in a Buck converter with one switch, reduce voltage ripple reduction is accomplished by select a bigger capacitor at the output but the transient time, as well as cost will increase. In order to decrease power losses in the power switches, one can decrease the switching frequency but this process will increase ripple voltage and can adverse effect on the output voltage waveform. In this paper, a novel

configuration of Buck converter and a novel configuration of Boost converter are introduced which operate under current continuous mode of operation (CCM) [16]. In this configuration by utilizing two storage devices will have less damaging effects on circuit parameters. these novel converters has two inductors two switches which can improve several factors over conventional converters by considering a delay time between these two switches which will be explained in the next section. These factors are namely; output voltage ripple, maximum input current, transient time, and maximum of transferable power.

II. OPERATIONAL PRINCIPLE OF THE CONVERTERS

Figs. 1 and 2 show the topologies of the new Buck and Boost converters respectively.

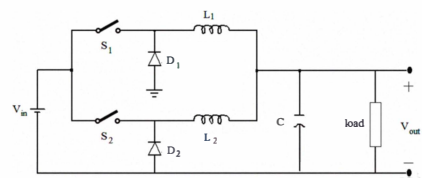

Fig. 1. The novel Buck converter

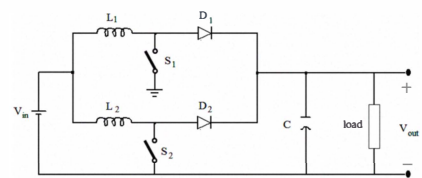

Fig. 2. The novel Boost converter

Each topology composed of two inductors (i.e. L1, L2), two diodes (i.e. D1, D2) and two switches (i.e.S1, S2). In experimental cases these ideal switches can be replaced by power transistors. These switches have the same switching frequency (f) and duty cycle (D) in PWM applications [1]. The only difference between these switches is that one switch has a delay time; this delay time is half of the switching period ($T/2$) as shown in Fig. 3 when D is smaller than 0.5 and is shown in Fig. 4 when D is larger than 0.5.

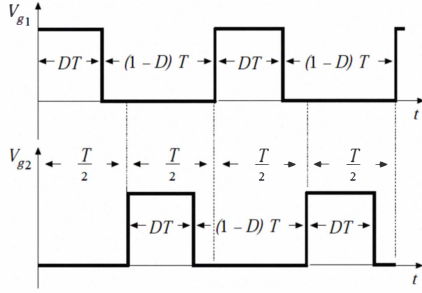

Fig. 3. The gate pulses of S1 and S2 when $D < 0.5$

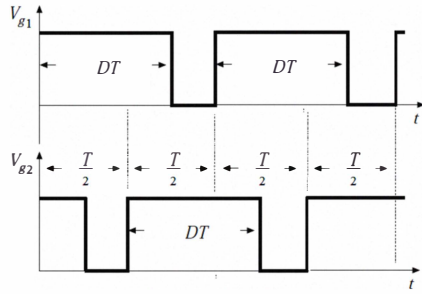

Fig. 4. The gate pulses of S1 and S2 when $D > 0.5$

III. ANALYSIS OF THE NOVEL CONVERTERS

The new Buck and novel Boost converters undergo four different topological states as shown in Figs. 5 and 6 respectively.

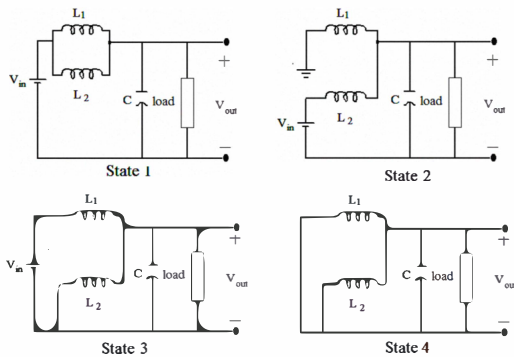

Fig. 5. Four variety conditions of the Novel Buck Converter

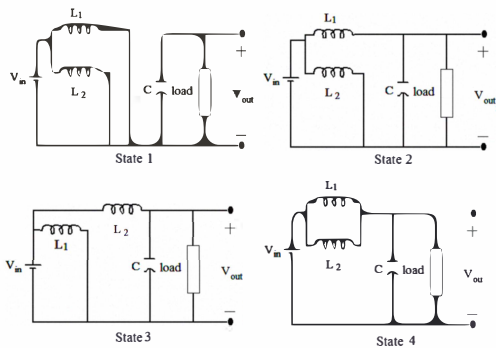

Fig. 6. Four variety conditions of the Novel Boost Converter

Every state for each new converter is explained in following manner;

State 1: In this state, S1, S2 are turned on. Both inductors (L1, L2) are charging up. D1, D2 are in reversed bias mode. This condition only can happen when $D > 0.5$.

State 2: In this state, S1 is switched off and L1 is discharging into the load by forward biasing of diode D1. S2 is turned on, L2 is charging up and D2 is in reversed bias mode.

State 3: In this state, S1 is turned on; L1 is charging up and D1 is in reversed bias mode. S2 is switched off and L2 is discharging in the path that contains L2, load and D2.

State 4: In this state, S1, S2 are turned off. Both inductors (L1, L2) are discharging into the load by forward biasing of two diodes D1 and D2. This condition can only occur when $D < 0.5$.

All these states for each three novel converters can be summarized in table I.

TABLE I. Different States for each new converter

Novel converter	states	S1	S2	D1	D2	L1	L2	Elements which feeding load
buck	State 1	on	on	off	off	Charging	Charging	L1, L2 & C
	State 2	off	on	on	off	Discharging	Charging	L1, L2 & C
	State 3	on	off	off	on	Charging	Discharging	L1, L2 & C
	State 4	off	off	on	on	Discharging	Discharging	L1, L2 & C
boost	State 1	on	on	off	off	Charging	Charging	C
	State 2	off	on	on	off	Discharging	Charging	L1 & C
	State 3	on	off	off	on	Charging	Discharging	L2 & C
	State 4	off	off	on	on	Discharging	Discharging	L1, L2 & C

As mentioned in the above, at any moment, the load is being fed by two independent paths. Hence, for a given voltage level it can transfer more power in comparison with conventional converters.

A. The new Buck Converter

While S1 is switched on, the voltage drops on L1 which is $V_{in} - V_{out}$ will take DT seconds. When S1 is switched off, the voltage drops on L1 during this time is $-V_{out}$ and it will take $(1-D)T$ seconds. So:

$$(V_{in} - V_{out})DT + V_{out}(1 - D)T = 0 \quad (1)$$

Therefore the expression for the input voltage (V_{in}) and the average of output voltage (V_{out}) can be summarized as:

$$V_{out} = DV_{in} \quad (2)$$

While L1 is charging up, its current increases from $I_{L1,min}$ to $I_{L1,max}$. Thus current variation for L1 can be expressed as:

$$\Delta I_{L1} = I_{L1,max} - I_{L1,min} \quad (3)$$

The duration of this condition is:

$$V_{in} - V_{out} = L_1 (\Delta I_{L1} / DT) \quad (4)$$

Similarly, for L2:

$$\Delta I_{L2} = I_{L2,max} - I_{L2,min} \quad (5)$$

And:

$$V_{in} - V_{out} = L_2 (\Delta I_{L2} / DT) \quad (6)$$

It is assumed that this novel Buck converter is operating in continuous current mode and $L1=L2=L$, therefore the equations for minimum and maximum inductors current with the load R are:

$$I_{L1,max} = (DV_{in} / 2RL)(L + (1.5-D)RT) \quad (7)$$

$$I_{L1,min} = (DV_{in} / 2RL)(L + (D-0.5)RT) \quad (8)$$

$$I_{L2,max} = (DV_{in} / 2RL)(L + (0.5-D)RT) \quad (9)$$

$$I_{L2,min} = (DV_{in} / 2RL)(L + (D-1.5)RT) \quad (10)$$

B. Analysis of the New Boost Converter

While S1 is switched on, the voltage drops on L1 is V_{in} and it takes DT seconds. When S1 is switched off, the voltage drops on L1 is $V_{in}-V_{out}$ and it takes $(1-D)T$ seconds. So:

$$V_{in} DT + (V_{in} - V_{out})(1 - D)T = 0 \quad (11)$$

Therefore the expression for the input voltage (V_{in}) and the average of output voltage (V_{out}) can be summarized as:

$$V_{out} = V_{in} / (1 - D) \quad (12)$$

While L1 is charging up, its current increases from $I_{L1,min}$ to $I_{L1,max}$. Thus current variation for L1 can be expressed as:

$$\Delta I_{L1} = I_{L1,max} - I_{L1,min} \quad (13)$$

The duration for this condition is:

$$V_{in} = L_1 (\Delta I_{L1} / DT) \quad (14)$$

Similarly, for L2:

$$\Delta I_{L2} = I_{L2,max} - I_{L2,min} \quad (15)$$

And:

$$V_{in} = L_2 (\Delta I_{L2} / DT) \quad (16)$$

It is assumed that this novel Boost converter is operating in continuous current mode and also $L1=L2=L$. The equations for minimum and maximum of inductors current with R as the load are:

$$I_{L1,max} = (V_{in} / [4RL(1-D)^2]) (2L + RTD(1-D)^2) \quad (17)$$

$$I_{L1,min} = (V_{in} / [4RL(1-D)^2]) (2L - RTD(1-D)^2) \quad (18)$$

$$I_{L2,max} = I_{L1,max} \quad (19)$$

$$I_{L2,min} = I_{L1,min} \quad (20)$$

This circuit simulated by MATLAB. The inductors currents for the each novel topology are shown in Figs. 6 and 7.

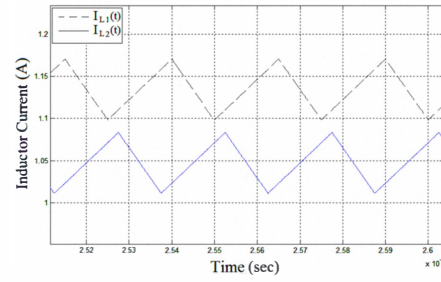

Fig. 6. Inductors Current for the Novel Buck Converter

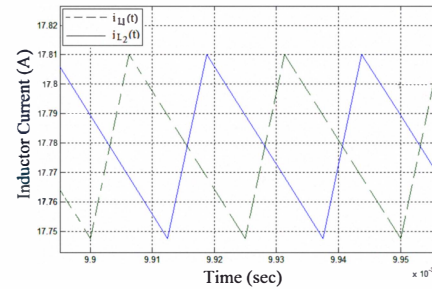

Fig. 7. Inductors Current for the Novel Boost Converter

IV. ADVANTAGES AND SIMULATION RESULTS

In this section some of the benefits that can be obtained from the novel configurations in comparison to the conventional converters are presented.

The conventional Buck and Boost are shown in Figs. 8 and 9 respectively. The maximum and minimum of inductor current equations are presented in (21) and (22) for conventional Buck converter and also in (23) and (24) for conventional Boost converter, respectively.

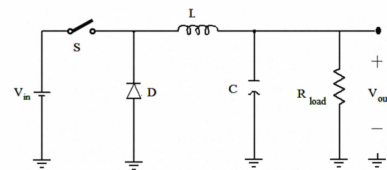

Fig. 8. The Conventional Buck Converter

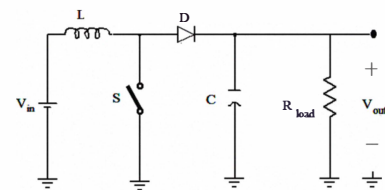

Fig. 9. The Conventional Boost Converter

$$I_{L,max} = (DV_{in} / 2RL)(2L + (1-D)RT) \quad (21)$$

$$I_{L,min} = (DV_{in} / 2RL)(2L - (1-D)RT) \quad (22)$$

$$I_{L,max} = (V_{in} / [2RL(1-D)^2])(2L + RTD(1-D)^2) \quad (23)$$

$$I_{L,min} = (V_{in} / [2RL(1-D)^2])(2L - RTD(1-D)^2) \quad (24)$$

The first advantage of these novel converters is that their maximum ripples voltage which is almost half as much as the conventional converters. This is summarized in table II, and shown in Figs. 10 and 11 respectively for Buck and Boost converters.

Type of Converter	Voltage ripple of conventional converter	Voltage ripple of Novel Converter
Buck	$(RTV_{in}/L)D(1-D)$	$(RTV_{in}/L)D(1-2D)$
Boost	$V_{in}/(1-D)^2$	$V_{in}/[2(1-D)^2]$

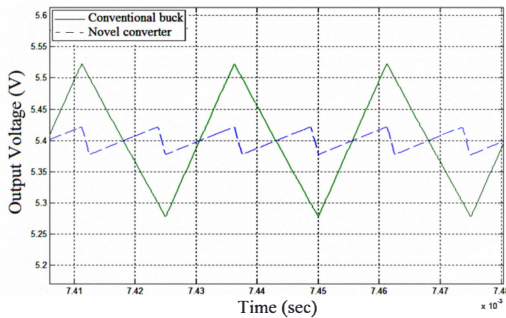

Fig. 10. Voltage Ripple of Buck Converter

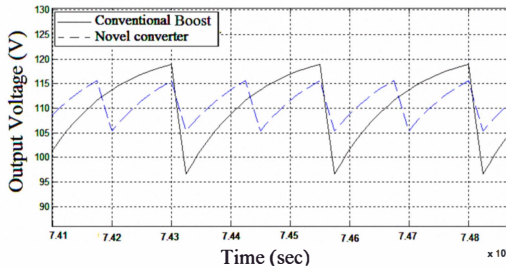

Fig. 11. Voltage Ripple of Boost Converter

Novel Buck converter has a special trait. The ripple voltage of this converter is almost zero when duty cycle is 0.5. This is driven from table 2 and is obtained at Fig. 12.

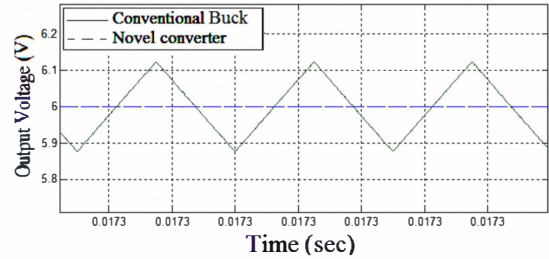

Fig. 12. Ripple Voltage for Buck converter with $D = 0.5$

The second advantage is the ratio of the maximum inductor current in the novel converters presented by equations (7) and (17) respectively to the maximum of inductor current equations in conventional converters presented in (21) and (23) respectively which show higher attainable current magnitude almost doubled for the new converter circuits. Hence, for a given voltage level, the maximum of transferable power increases by a factor of two.

The third advantage is the maximum current out of voltage source in the novel converters when $D < 0.5$, is almost half of the maximum input current in a conventional converters. Of course only novel Buck converters have this advantage; in the novel Boost converter, the input current is continues. This issue is simulated by MATLAB and is shown in Figs. 13 and 14.

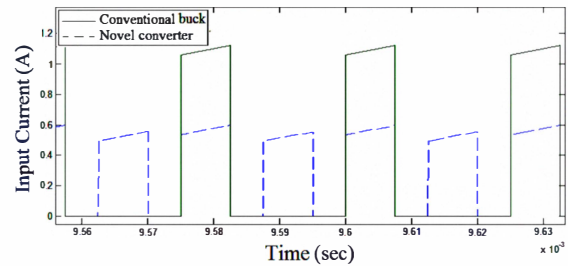

Fig. 13. Input Currents of Buck converter

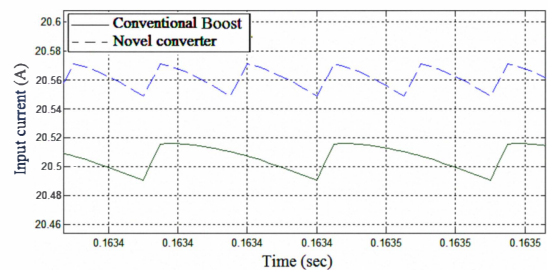

Fig. 14. Input Currents of Boost converter

The fourth advantage is related to power losses regarding the power switches. In these novel converters the power losses are almost half of the power losses in conventional converters. This issue has been achieved for two reasons. first is the maximum of inductors current in novel converter is almost half of the maximum of inductors current in conventional converters and the second one is the power losses in each switch is proportion to square of current, I , flowing through them where I is the switch current.

Finally, the last advantage obtained is related to the transient response time. It is smaller than the response time of the conventional dc to dc converters. This fact is shown in Figs 15 and 16 for these novel converters.

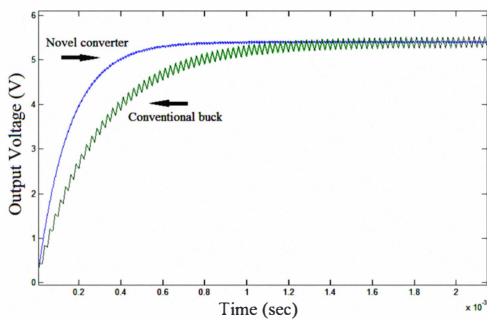

Fig. 15. The response time of Buck converter

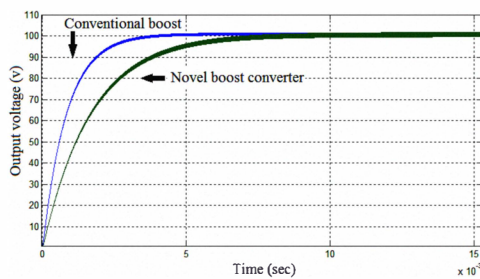

Fig. 16. The response time of Boost converter

V. EXPERIMENTAL RESULTS

These novel converters are built in the laboratory and their circuits are shown in Fig. 17.

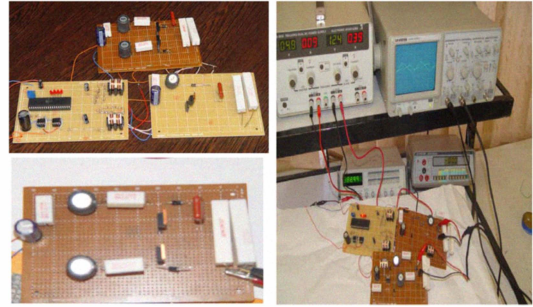

Fig. 17. The circuit structures

The currents of the two inductors for the novel converters are obtained shown as Figs. 18 and 19.

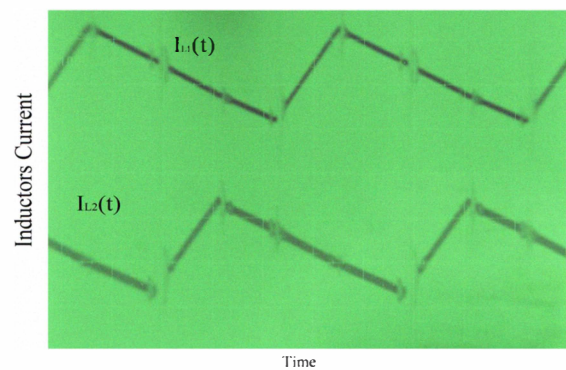

Fig. 18. I_{L1} and I_{L2} Currents in time division=5us for Buck Converter

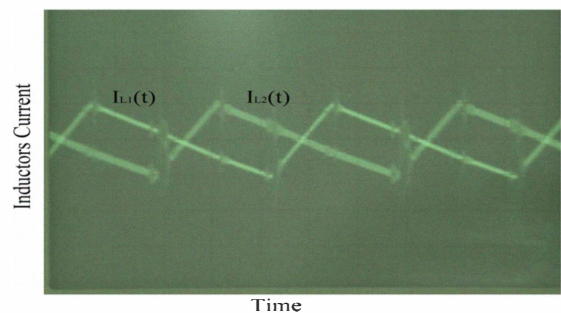

Fig. 19. I_{L1} and I_{L2} Currents in time division=5us for Boost Converter

Figs. 20 and 21 show the comparison between the output voltages of converters with a conventional one having the same load value.

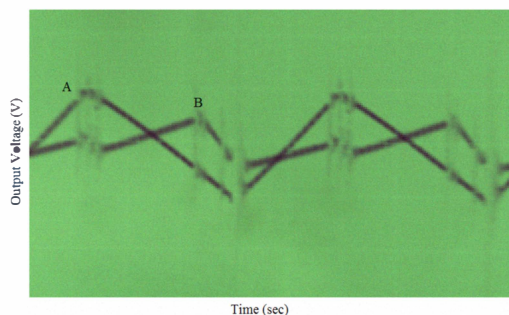

Fig. 20. Output Voltage of: A) Conventional Buck
B) The novel Buck

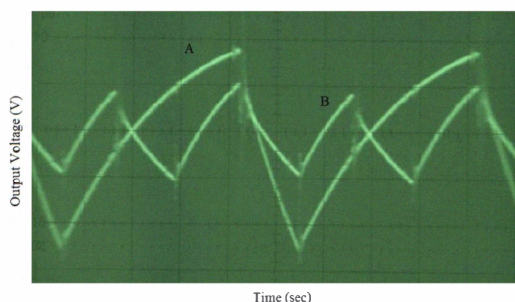

Fig. 21. Output Voltage of: A) Conventional Boost
B) The novel Boost

Figs. 22 and 23 show the comparison between the input currents of the novel converters with conventional ones. In these Figs., the input current of conventional converters is placed on top while the input current of novel converters is shown in the bottom part of these Figs.

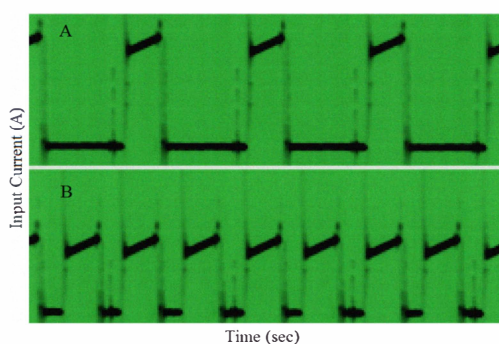

Fig. 22. Input Current of: A) Conventional Buck
B) The novel Buck

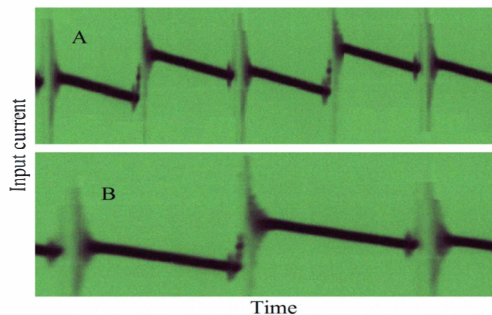

Fig. 23. Input Current of: A) Conventional Boost
B) The novel Boost

All Figs. have been obtained by laboratory experiment which shows the same results as the ones obtained through simulations.

VI. CONCLUSION

This paper presents successfully the analysis, simulation, experimental results of new configurations of two novel dc to dc converters. It then continues with the comparison with conventional converters. The novel converters show higher output power (almost twice as much) as well as lower ripple factor (half) when compared to the conventional converters.

REFERENCES

- [1] Rashid M. H. "Power Electronics: Circuits, Devices and Applications" Second edition, Prentice-Hall, USA, 1993.
- [2] Mohan N., Undeland T. M. and Robbins W. P. "Power Electronics: Converters, Applications and Design" John Wiley & Sons, New York, 1995.
- [3] R. Erickson, Fundamentals of Power Electronics. New York: Chapman & Hall, 1997, ch. 9 & 11.
- [4] S.D. Mitchell, S.M. Ncube, T.G. Owen, and M.H. Rashid, "Applications and market analysis of dc-dc converters," in Proc. ICECE, 2008, pp. 887-891.
- [5] M.B. Camara, H. Gualous, F. Gustin, A. Berthon, and B. Dakyo, "DC/DC converter design for super capacitor and battery power management in hybrid vehicle applications-polynomial control strategy," IEEE Trans. Ind. Electron., vol. 57, no. 2, pp. 587-597, Feb. 2010.
- [6] J. chen, D. Masimovic, and R.W. Erickson, "Analysis and design allow stress Buck-Boost converter in universal-input PFC application," IEEE Trans. Power Electron., vol. 21, no. 2, March 2006.
- [7] Boni, A.; Carboni, A.; Facen, A., "Design of fuel-cell powered DC-DC converter for portable applications in digital CMOS technology" Electronics, Circuits and Systems, 2006. ICECS '06. 13th IEEE International Conference on 10.1109/ICECS.2006.379763.
- [8] Choon-Keat Chew; Rama Rao Kondapalli, S.; "Modeling, Analysis, Simulation and Design Optimization (Genetic Algorithm) of dc-dc Converter for Uninterruptible Power Supply Applications ",

- [9] G. W. Wester, "Describing-function analysis of a ripple regulator with slew-rate limits and time delays," in Proc. IEEE Power Electronic Specialists Conf., 1990, pp. 341–346.
- [10] "Designing Fast Response Synchronous Buck Regulators Using the TPS5210," Texas Instruments, Dallas, TX, Mar. 1999.
- [11] Y.J. Lee , A. Khaligh, A. Chakraborty, and A. Emadi, "Digital combination of Buck and Boost converters to control a positive Buck-Boost converter and improve the output transients," IEEE Trans. Power Electron., vol. 24, no. 5, pp. 1267-1279, May 2009.
- [12] C. Zhang, Z. Liao, and M. Yang, "Research on soft start method for Buck-Boost bi-directional dc-dc converter of fuel cell power system," in Proc. PACCS, 2009, pp. 326-329.
- [13] J. A. Abu-Qahouq, N. Pongratananukul, I. Batarsch, and T. Kasparis, "Multiphase voltage-mode hysteretic controlled VRM with DSP control and novel current sharing," in Proc. Fourth IEEE Int. Conf. Devices, Circuits, and Systems, Apr. 2002, pp. P017.1–P017.7.
- [14] K. Stisumrit and K. Tripech, "Analysis continuous conduction mode of Buck-Boost converter using bridge rectifier control," in Proc. ICIEA, 2006, pp. 1-4.
- [15] J. Xu, and M. Qin, "Multi-pulse train control technique for Buck converter in discontinuous conduction mode," IET Power Electron., vol. 3, no. 3, pp. 391-399, May 2010.
- [16] A. Reatti, M. K. Kazimierczuk "Small-Signal Model of PWM Converters for Discontinuous Conduction Mode and Its Application for Boost Converter," IEEE Transactions of Circuits and Systems-I: Fundamental Theory and Applications, vol. 50, no. 1, pp. 65-73, January 2003.