

# Optimal Operation by Controllable Loads Based on Smart Grid Topology Considering Insolation Forecasted Error

Kenichi Tanaka, *Student Member, IEEE*, Kosuke Uchida, *Student Member, IEEE*, Kazuki Ogimi, *Student Member, IEEE*, Tomonori Goya, *Student Member, IEEE*, Atsushi Yona, *Student Member, IEEE*, Tomonobu Senjyu, *Senior Member, IEEE*, Toshihisa Funabashi, *Senior Member, IEEE*, and Chul-Hwan Kim, *Senior Member, IEEE*

**Abstract**—From the perspective of global warming mitigation and depletion of energy resources, renewable energy such as wind generation (WG) and photovoltaic generation (PV) are getting attention in distribution systems. Additionally, all electric apartment houses or residence such as dc smart houses are increasing. However, due to the fluctuating power from renewable energy sources and loads, supply-demand balancing of power system becomes problematic. The smart grid is a solution to this problem. This paper presents a methodology for optimal operation of a smart grid to minimize the interconnection point power flow fluctuation. To achieve the proposed optimal operation, we use distributed controllable loads such as battery and heat pump. By minimizing the interconnection point power flow fluctuation, it is possible to reduce the electric power consumption and the cost of electricity. This system consists of a photovoltaic generator, heat pump, battery, solar collector, and load. To verify the effectiveness of the proposed system, results are used in simulation presented.

**Index Terms**—DC smart house, interconnection point power flow, optimal operation, smart grid.

## I. INTRODUCTION

**D**UE TO GLOBAL warming and exhaustion of fossil fuels, we are required to reduce CO<sub>2</sub> emissions and energy consumption. However, CO<sub>2</sub> emissions and energy consumption are increasing rapidly due to the proliferation of all-electric houses. As countermeasures against these problems, in residential sector, insolation of photovoltaic (PV) system and solar collector (SC) system is proposed. On the other hand, many of the dispersed generators such as PV can be connected to dc sources and dc systems are expected to be of high efficiencies and lower cost due to the absence of inverter and rectifier

circuits. It is possible to operate PV and SC systems in residential house with high efficiency. Therefore, these equipments can help to reduce the use of fossil fuel and the emission of CO<sub>2</sub>. As these research, suppress of power fluctuation by renewable energy is proposed [1]–[12]. However, installation of renewable energy causes frequency fluctuation and distribution voltage fluctuation because output power from renewable energy fluctuates due to weather conditions. In addition, electricity cost is determined by maximum electric power consumption for the year. Hence it is possible to reduce electricity cost by achieving load following control using a power storage facility. It is necessary to smooth power flow from the distribution system to achieve above technical problems and reduce electricity cost. Because of the above factors, the smart grid concept is developed which cooperatively balances supply-demand between the power supply side and power demand side [13], [14]. The smart grid optimizes the whole power system based on operation such as unit commitment problem for thermal power generation in the supply side [15] and controllable loads in the demand side by exchanging each information using a smart meter. Reference [15] decides the schedule of thermal unit commitment in the power system integrated with the controllable load and battery. However, [15] mainly focuses on the supply side in the power system, so it is important to consider the demand side. As a countermeasure at the demand side, for maintaining supply-demand balance, controllable loads can be used. The study of supply-demand balancing by power consumption control of controllable load at each demand side in a small power system is already reported in [16]. By applying the smart grid concept, we can expect high efficiency power supply, energy conservation and low-carbon society. As a countermeasure at the demand side for maintaining supply-demand balance, it is possible to control in controllable loads which are introduced in all-electrification houses. These all-electric homes are becoming common in Japan and could connect ZigBee with wireless systems between each home. In fact, the research of supply-demand balancing by power consumption control of controllable load at each demand side in a small power system is already proposed [17]. The optimal power flow based on the smart grid is calculated using an optimization technique.

This paper presents an optimal operation method of a dc smart-house group with the controllable loads in residential houses as smart grid. The dc smart house consists of a solar collector (SC), a PV, a heat pump (HP), and a battery. HP

Manuscript received June 20, 2010; revised September 25, 2010; accepted May 03, 2011. Date of current version August 24, 2011. Paper no. TSG-00080-2010.

K. Tanaka, K. Uchida, K. Ogimi, T. Goya, A. Yona, and T. Senjyu are with the Department of Electrical and Electronics Engineering, Faculty of Engineering, University of the Ryukyus, Okinawa, Japan (e-mail: k098544@eve.u-ryukyu.ac.jp; k098533@eve.u-ryukyu.ac.jp; e075511@eve.u-ryukyu.ac.jp; k108532@eve.u-ryukyu.ac.jp; yona@tec.u-ryukyu.ac.jp; b985542@tec.u-ryukyu.ac.jp).

T. Funabashi is with the Meidensha Corporation, Tokyo, Japan (e-mail: funabashi-t@mb.meidensha.co.jp).

C.-H. Kim is with the School of Electrical and Computer Engineering, Sungkyunkwan University, Suwon City 440-746, Korea, and NPT Center (e-mail: chkimskku@yahoo.com).

Color versions of one or more of the figures in this paper are available online at <http://ieeexplore.ieee.org>.

Digital Object Identifier 10.1109/TSG.2011.2158563

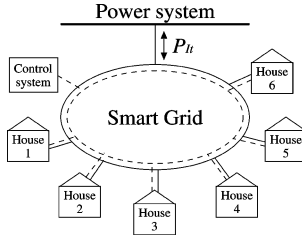

Fig. 1. Smart grid model.

and battery are used as controllable loads in this paper. The proposed method has been developed in order to achieve the interconnection point power flow within the acceptable range and the reduction of max-min interconnection point power flow error as low as possible to smooth the supply power from distribution system. Power consumption of controllable load determines to optimize the max-min interconnection point power flow error based on information collected from power system through communication system. By achieving the proposed method, we can reduce the interconnection point power flow fluctuation, and it is possible to reduce electricity cost due to the reduction of the contract fee for the electric power company. Also, by using a battery as the power storage facility, which can operate rapidly for charge and/or discharge, the rapid output fluctuations of dc load and PV generator are compensated. Effectiveness of the proposed control system is validated by simulation results using MATLAB.

## II. POWER SYSTEM MODEL

In this section, configuration of the proposed smart grid is described. The smart grid and dc smart house are described in Section II-A, and the PV system and SC system are described in Section II-B and Section II-C, respectively.

### A. Smart Grid System

The smart grid model is shown in Fig. 1. The smart grid has six smart houses, and connected to power system and control system through transmission line and communications infrastructures. The control system sends required control signals to smart-house group which response to system conditions. The interconnection point power flow is the power flow from the power system to smart grid in Fig. 1. DC smart-house model is shown in Fig. 2, which consists of a dc load, a PV generator, a SC, a HP, and a battery. HP and battery are used as controllable loads. Battery capacity is 30 kWh and inverter capacity is 4 kW. HP is used for hot water supply. The standard is a 370 L type with 1.5 kW heater, to heat the water till 55 °C (summer) and 85 °C (winter) using midnight power in general. In this paper, we assume a summer day as simulation case.

### B. Photovoltaic System

Amount of PV generation  $P_s$  can be calculated by

$$P_s = \eta S \alpha I_a (1 - 0.005(t_o - 25)) \quad [\text{kWh}] \quad (1)$$

where  $\eta$  is the conversion efficiency of PV array (%),  $S$  is the array area ( $m^2$ ),  $I_a$  is the solar radiation ( $\text{kW}/m^2$ ),  $t_o$  is the outside air temperature ( $^{\circ}\text{C}$ ).

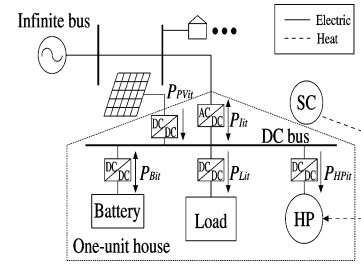

Fig. 2. DC smart-house model.

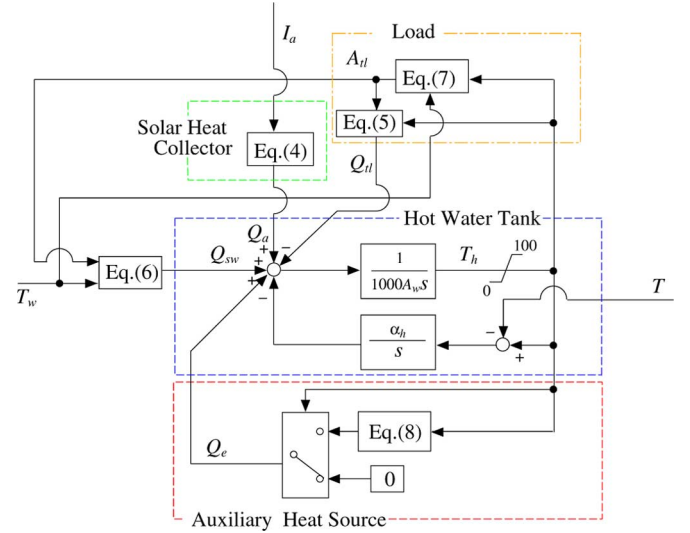

Fig. 3. Model of solar collector system.

In this paper, it is assumed that sum of total insolation are falling on the PV array, and the angle of incidence is not considered.

### C. Solar Collector System

The proposed solar collector system has HP as the auxiliary heating source. The hot-water temperature in storage tank is adjusted by diluting with water, and hot water is supplied to the house. In case the hot-water temperature in storage tank is lower than 60 °C at 19:00, the hot water in storage tank is heated to 60 °C by HP.

The SC system can be described by (2) ~ (8)[18]. Fig. 3 shows the numerical model of SC system. The temperature alteration and dynamic characteristic of water temperature can be written as

$$\frac{dT_h}{dt} = \frac{Q_h}{\beta A_w} \quad (2)$$

$$\frac{dQ_h}{dt} = -\alpha_h(T_h - T) \quad (3)$$

where  $T_h$  is the hot-water temperature in storage tank,  $Q_h$  is the heat quantity of the hot water in the storage tank,  $\beta$  is the unit conversion parameter ( $\beta = 1000 \text{ g/L}$ ),  $A_w$  is the tank capacity,  $\alpha_h$  is the coefficient of heat transfer,  $T$  is the air temperature.

Calories obtained from solar radiation can be calculated by

$$Q_a = \eta_h I_a S_c \quad [\text{J}] \quad (4)$$

where  $\eta_h$  is the heat transfer coefficient,  $S_c$  is the solar collector area.

TABLE I  
PARAMETERS OF HEAT COLLECTOR AND ELECTRICAL HEATER SYSTEM

Solar Heater Collector		
Heat collection efficiency	$\eta_h$	60%
Heat collection area of one panel	$A_c$	1.655m <sup>2</sup>
Number of panels	$A_c$	3 panels
Electrical heater		
Boiler efficiency	$\eta_b$	80%
Capacity of water storage tank	$A_w$	370l
Heat transfer coefficient	$\alpha_h$	0.0060209

In this paper, it is assumed that sum of total insolation will be falling on the solar collector and array, and it does not consider the incidence angle of insolation an solar collector array.

Using the calories from the hot water in the storage tank  $Q_{tl}$  and obtained the calories by water supply  $Q_{sw}$  can be calculated by

$$Q_{tl} = \beta A_{tl} T_h \quad [J] \quad (5)$$

$$Q_{sw} = \beta A_{sw} T_w \quad [J] \quad (6)$$

$$A_{tl} = A_{sw} = \frac{T_l - T_w}{T_h - T_w} A_l \quad [J] \quad (7)$$

$$Q_e = \beta A_w (T_e - T_h) \quad [J] \quad (8)$$

where  $T_l$  is the temperature of the hot-water supply,  $T_w$  is the temperature of municipal water,  $A_l$  is the supplied hot water of the house, and using the hot water from the storage tank  $A_{tl}$  is equal to the supplied water  $A_{sw}$ . If there is no solar radiation and the water temperature is still below the desired temperature  $T_e$ , the HP provide calorie  $Q_e$ . Equation (1)–(8) can be used for the model of PV system and solar collector system. Based on forecasted insolation data, the PV power output and the amount of SC heat collection are calculated by (1) and (4), respectively. The HP operation time is determined by (8) based on Fig. 3. After determining the HP operation time, the charge/discharge power of battery and the HP operation time for each smart house are optimized by tabu search based on an objective function and constraints. The parameters of the heat collector and electrical heater system are shown in Table I.

### III. OPTIMIZATION METHOD

In this section, optimal operation of the smart grid is determined to minimize interconnection point power flow fluctuations. Objective function and constraints are described in Section III-A, and tabu search is described in Section III-B.

#### A. Setup of Objective Function

From Fig. 2,  $P_{Iit}$ ,  $P_{Lit}$ ,  $P_{B_{it}}$ ,  $P_{PV_{it}}$ ,  $P_{HP_{it}}$  represent the interconnection point power flow, power consumption except controllable loads, power consumption of battery, PV output power, and power consumption of HP for each smart house, respectively, and the whole active power for these variables in the smart grid are equal to the following:

$$P_{I_t} + P_{B_t} + P_{PV_t} - P_{HP_t} = P_{L_t}. \quad (9)$$

Supply-demand balancing can maintain the equilibrium state to satisfy the above equation. In this paper, the objective function minimizes the interconnection point power flow fluctuation.

Due to the reduction of interconnection point power flow fluctuation, it is possible to suppress the harmful effects to the power system, and it is possible to reduce electricity cost. The objective function and constraints are described by the following equations:

Objective function :

$$\min F = \sum_{t \in T} (B_{I_{cen}} - P_{I_t})^2 + \sum_{t \in T} \text{pena}. \quad (10)$$

Constraints :

$$B_{I_{min}} < P_{I_t} < B_{I_{max}} \quad (11)$$

$$|P_{B_{it}}| < P_{B_{max}} \quad (12)$$

$$C_{B_{min}} < C_{B_{it}} < C_{B_{max}}. \quad (13)$$

$$0.4 \times C_{B_{max}} < C_{B_{it}(t=2A)} < 0.6 \times C_{B_{max}}. \quad (14)$$

where

$T$	all time section;
$I$	smart-house $i$ group;
$i$	smart-house index;
$P_{I_t}$	interconnection point power flow from power system to smart grid;
$B_{I_{cen}}$	interconnection point power flow bandwidth central value;
$\text{pena}$	a penalty function produced by deviating constraints;
$B_{I_{min}}$	interconnection point power flow bandwidth minimum value;
$B_{I_{max}}$	interconnection point power flow bandwidth maximum value;
$P_{B_{it}}$	charge/discharge power of battery;
$P_{B_{max}}$	charge/discharge power maximum value of battery;
$C_{B_{it}}$	remaining energy capacity of battery;
$C_{B_{min}}$	battery capacity minimum value;
$C_{B_{max}}$	battery capacity maximum value.

Where the bandwidth is defined for interconnection point power flow in (11); the relaxation of the restricted condition. We set power flexibility to  $\pm 10\%$  from power reference  $B_{I_{cen}}$  given by power system in this paper. Equations (12) and (13) show battery inverter and capacity constraints, and  $P_{B_{max}} = 4$  kW,  $C_{B_{min}} = 20\%$  and  $C_{B_{max}} = 80\%$ , respectively. Furthermore, proposed configuration of electric price as shown in Fig. 4 assumes the smart grid system in the future. If interconnection point power flow within the bandwidth (Region A only), electric purchase cost is 10 Yen/kWh, and if interconnection point power flow departs from the bandwidth (Regions B and C), electric purchase cost are 20 Yen/kWh and 30 Yen/kWh, respectively. Moreover, electric selling cost to power system is 10 Yen/kWh. The bandwidth is given by power system to smart grid as power reference. Therefore, it is important that the customer

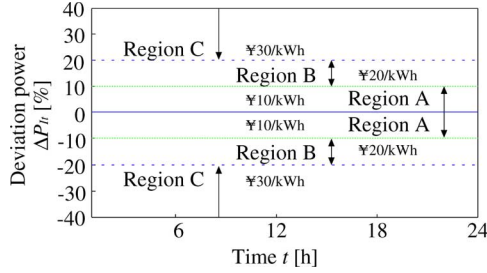

Fig. 4. Electric price.

follows the power reference and interconnection point power flow within the bandwidth.

### B. Tabu Search

TS is a local search methodology, and is used for optimal technique in order to address the problems for determine the charge/discharge power of battery and HP operation time for each smart house. In this paper, it is possible to determine the heating time of HP by assuming power consumption except controllable loads and heat load can be forecasted. Therefore, the charge/discharge power of battery and HP operation time for each smart house are calculated by using tabu search under the objective function and constraints. Of course, the proposed method can be calculated according to other optimization method such as dynamic programming and GA. However, the searching area is not wide scale so we adopt tabu search. The details of the optimization is described as follows.

- 1) It is possible to forecast loads except controllable load for electrical and heat at each smart house, and PV power output and amount of SC heat collection are forecasted based on insolation forecasting method.
- 2) When hot-water temperature in storage tank is lower than 60 °C at 19:00, hot water is heated to 60 °C by HP. HP is heated to the heat requirement in time average.
- 3) Based on the objective function and constraints, we determine the charge/discharge power of battery and HP operation time for each smart house by using tabu search.

TS algorithm is an extended local search algorithm. By introducing a memory system called tabu list to record the latest moves, TS algorithm can escape from the current local. TS algorithm has advantages like high search efficiency of the local search algorithm and global search ability of the intelligent algorithm.

The flow chart of tabu search is shown in Fig. 5, and the searching procedure of TS algorithm can be described as follows.

- Step 1: The initial search origin is determined. The tabu list is formatted.
- Step 2: The neighborhood solutions around the origin are evaluated.
- Step 3: For the neighborhood solutions evaluation, the best neighborhood solution is not recorded in the tabu list which is selected as the next origin. If the evaluated solution is better than the recorded best solution, the best solution is updated.

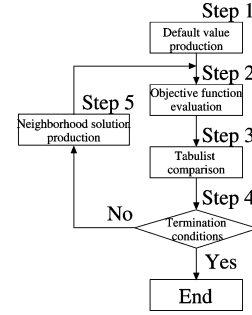

Fig. 5. Tabu search flow chart.

TABLE II  
FUZZY RULE

		$x_1$		Humidity			
				T	S	M	L
Amount of cloud	T	H	SH	L	SL	M	
	S	SH	L	SL	M	SS	
	M	L	SL	M	SS	S	
	L	SL	M	SS	S	ST	
	H	M	SS	S	ST	T	

T=Tiny ST=Slightly Tiny S=Small  
 SS=Slightly Small M=Medium SL=Slightly Large  
 L=Large SH=Slightly Huge H=Huge

Step 4: If the conditions of termination are satisfied, the search process is terminated. Otherwise, go to 5.

Step 5: For the best solution in Step 3, the neighborhood solutions are generated.

In this paper, it is possible to determine heating time of HP by assuming power consumption except controllable loads and heat load can be forecasted. Therefore, the charge/discharge power of battery and heating time of HP are calculated by tabu search. In addition, TS produces much the same results each time because it has a small variables, narrow searching area, and large searching number on optimization problem in this paper, and we propose optimal operation method of controllable loads, but do not focus on optimization method. Therefore, the optimization methodology is not described in detail. The following algorithmic implementation parameters are used for simulation:

<i>global_iteration_max</i>	1,000
<i>tabu_length</i>	30
<i>local_iteration_max</i>	48
<i>total number of variables</i>	12

### C. Insolation Forecasting Method

The insolation is forecasted by fuzzy logic using weather forecasting. The fuzzy rule is shown in Table II, and these inputs are humidity and amount of cloud. Fuzzy functions and PV output pattern are shown in Figs. 6 and 7, respectively. The insolation forecasted value uses the observed value at Naha in 2005, including error. The insolation forecasted error using fuzzy logic is corrected by PV output observed values. Fig. 8 shows the ratio of PV output observed value to PV output forecasted value, and its approximate curve sets to correction value. The PV power output error and distribution error obtained by

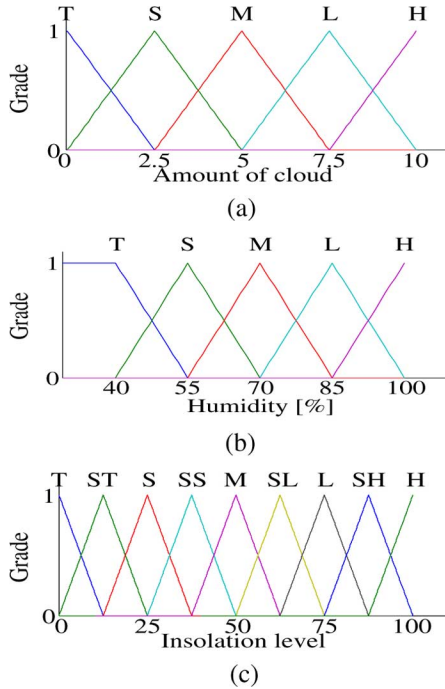

Fig. 6. Fuzzy functions. (a) Amount of cloud. (b) Humidity. (c) Insolation level.

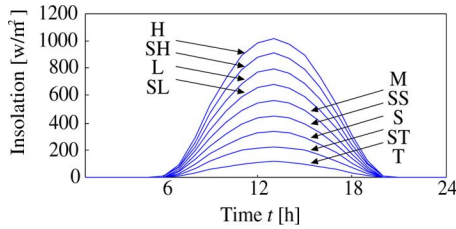

Fig. 7. PV output pattern.

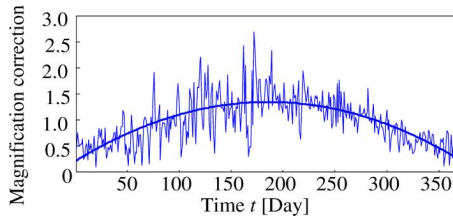

Fig. 8. Magnification correction.

correcting are shown in Fig. 9. It is confirmed that the error is decreasing by correcting. A step of insolation forecasting method is shown in the following.

- 1) The insolation is forecasted by fuzzy logic using a weather forecasting data.
- 2) Calculate a ratio of PV power output observed value to PV power output forecasted value, and its approximate curve sets to a correction value.
- 3) The PV power output error is decreased by correcting to forecasting value that is calculated based on fuzzy logic.

#### IV. SIMULATION RESULTS AND DISCUSSION

In this section, we present the simulation results and a discussion to verify the effectiveness of the proposed optimal method. Simulation conditions are described in Section IV-A, and the discussion at simulation results are described in Section IV-B.

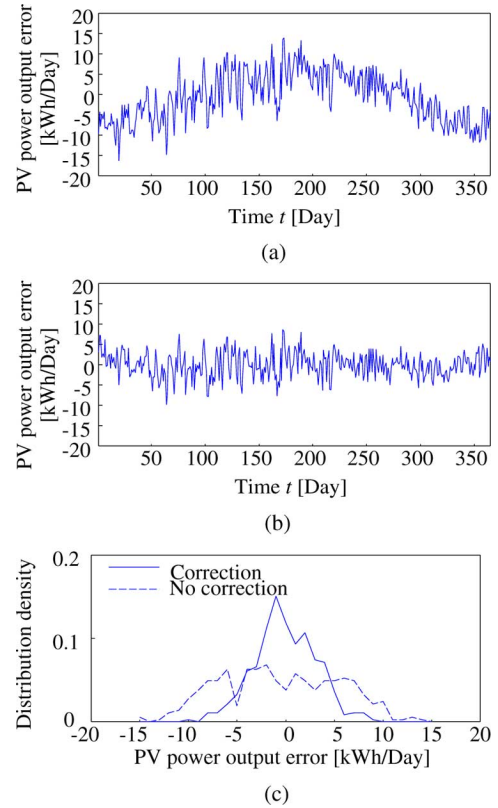

Fig. 9. PV error distribution. (a) PV power output error. (b) PV power output error with correction. (c) Error distribution.

#### A. Simulation Condition

For the smart grid model that has six smart houses as shown in Fig. 1, we assume that it is possible to forecast loads, and use forecasting data for PV power output of the smart house based on insolation forecasting. PV output power can be calculated from (1) using insolation. In addition, for heat loads of each smart house, we assume that three people used 100 L hot-water for 1 h in shower from 19:00 to 22:00. Therefore, a shower takes 3 h for 3 people in the simulation. Then the hot-water temperature in storage tank is lower than 60 °C at 19:00; the hot water in storage tank is heated to 60 °C by HP based on Fig. 3.

#### B. Simulation Results

Simulation results are shown in Fig. 10. Assuming power consumption except controllable loads and forecasting PV output power in each house are shown in Fig. 10(a) and 10(b), respectively, where total load and PV output power in smart grid are shown in the same Fig. 10(a) and 10(b). In these conditions, the hot-water temperature in the storage tank is lower than 60 °C at 19:00 for each smart house because insolation is not much obtained, as shown in Fig. 10(b). Then the hot water in the storage tank is heated to 60 °C by HP. The water temperature of the storage tank and power consumption of HP for each smart house are shown in Fig. 10(c) and 10(d), respectively. The water temperature in these conditions are higher than 60 °C at 19:00 by operating HP, and operating time of HP is determined based on the proposed optimal method. In addition, interconnection point power flow is shown in Fig. 10(e). Here,  $P_I$ ,  $P_L$ ,  $P_{HP}$ ,  $P_{PV}$ , and  $P_B$  show the whole

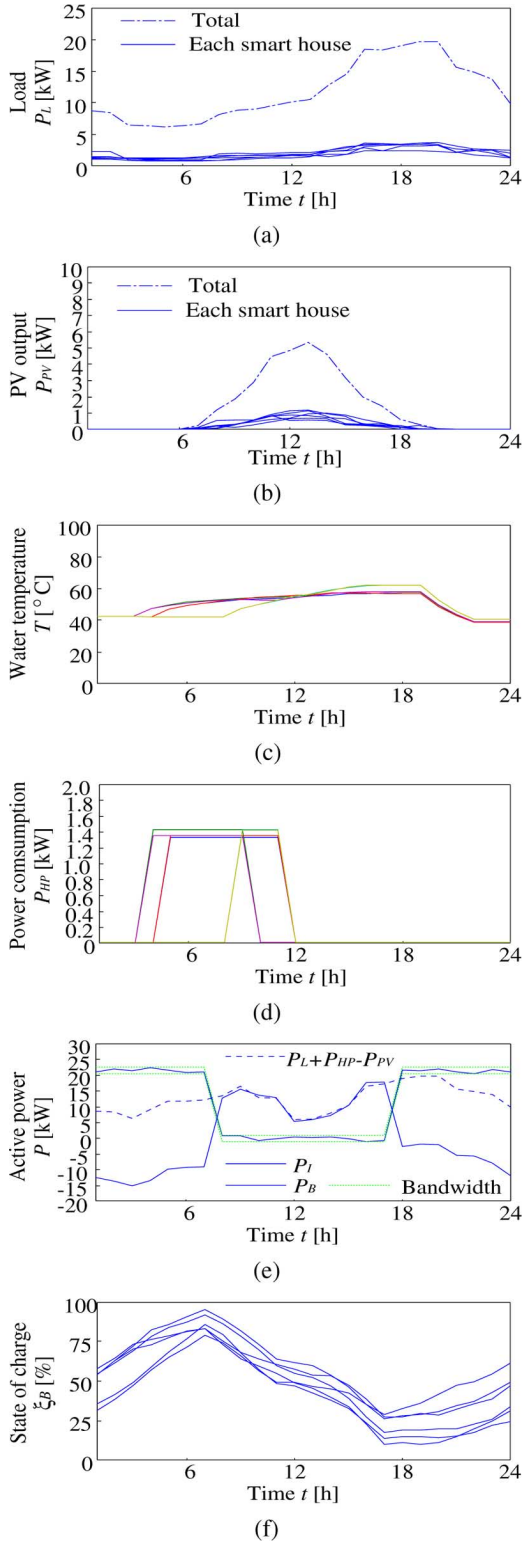

Fig. 10. Simulation results. (a) Power consumption except controllable loads. (b) PV output power. (c) Water temperature in storage tank. (d) Power consumption of HP. (e) Supplying power from infinite bus. (f) State of charge for battery.

active power for each equipment in the smart grid, and the bandwidth is the power reference given by the power system as shown in constraint (11). From this figure, interconnection point power flow within the bandwidth (Region A) and power consumption is smoothed by controlling controllable loads. The electricity cost for each house from the power system

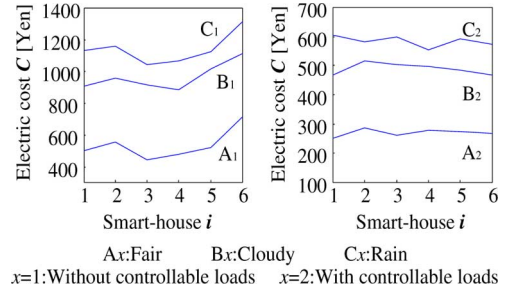

Fig. 11. Electricity cost of each houses.

is shown in Fig. 11. Each case  $A_x$ ,  $B_x$ , and  $C_x$  in Fig. 11 is depicted in sunny, cloudy, and rainy weather conditions, and subscript  $x = 1$  and  $2$  shows simulation cases without/with controllable loads, where the case without controllable loads in Fig. 11 is calculated by current electric cost used in Tokyo Electric Power Company as a conventional electric cost, and set to 21.87 Yen/kWh from 7:00 to 23:00 and otherwise 9.17 Yen/kWh (1 $\text{\$}$ =80.81 Yen). The simulation results of Fig. 10 stands for the electricity cost of case  $B_2$  as shown in Fig. 11. From Fig. 11, each house pays a similar electricity cost and it is possible to reduce the electricity cost compare to the without controllable load. In the sunny weather condition, PV power output and SC heat generation are highly generated due to sufficient insolation. Therefore, it is not necessary to heat by HP and the sunny weather condition is the lowest cost in the three cases. Reference [18] presents that the payout time for the needed investment costs is about 10 years for such assumed customer in this paper. Furthermore, the state of charge for the battery introduced in each smart house is shown in Fig. 10(f). From this figure, the charge/discharge control of battery is achieved within the acceptable range of battery capacity.

## V. CONCLUSION

This paper determines an optimal operation for a dc smart-house group in the smart grid, which consists of a battery and HP as controllable loads that may steadily increase in the demand side in the future. As an optimization method, we use the tabu search, which determines the operation method of controllable loads to suppress interconnection point power flow fluctuation within the bandwidth based on information obtained by the communications infrastructures. By smoothing interconnection point power flow, it is possible to reduce electricity cost due to the reduction of the contract fee of the electric power company. Power consumption in the smart grid is smoothed by achieving the proposed method, so we can suppress the impact of PV against power system. Furthermore, we show the concept of the smart grid introduced in all-electrification houses using controllable loads. Consequently, we can expect high-quality power supply and reduce the cost by cooperative control in the smart grid. The effectiveness of the proposed control system is validated by simulation results in MATLAB.

## REFERENCES

- [1] K. Kurohane, T. Senjyu, A. Yona, N. Urasaki, T. Goya, and T. Funabashi, "A hybrid smart AC/DC power system," *IEEE Trans. Smart Grid*, vol. 1, no. 2, pp. 199–204, Sep. 2010.

- [2] T. Senjyu, M. Tokudome, A. Yona, H. Sekine, T. Funabashi, and C.-H. Kim, "A frequency control approach by decentralized generators and loads in power systems," in *Proc. Power Energy Conf.*, Johor Bahru, Malaysia, Dec. 1–3, 2008, pp. 79–84.
- [3] M. Datta, T. Senjyu, A. Yona, T. Funabashi, and C.-H. Kim, "A coordinated control method for leveling PV output power fluctuations of PV-diesel hybrid systems connected to isolated power utility," *IEEE Trans. Energy Convers.*, vol. 24, no. 1, pp. 153–162, Mar. 2009.
- [4] A. Y. Saber, S. Chakraborty, S. M. A. Razzak, and T. Senjyu, "Optimization of economic load dispatch of higher order general cost polynomials and its sensitivity using modified particle swarm optimization," *Elect. Power Syst. Res.*, vol. 79, no. 1, pp. 98–106, Jan. 2009.
- [5] P. Taylor, "Increased renewable energy penetration on Island power systems through distributed fuzzy load control," in *Proc. Conf. Renewable Energies for Islands Toward 100% RES Supply*, Chania, Crete, Greece, Jun. 2001.
- [6] N. Duic and M. G. Carvalho, "Increasing renewable energy sources in Island energy supply: Case study porto santo," *Renewable Sustainable Energy*, vol. 8, pp. 383–399, 2004.
- [7] D. A. Katsaprakakis, N. Paradakis, G. Kozirakis, Y. Minadakis, D. Christakis, and K. Kondaxakis, "Electricity supply on the Island of dia based on renewable energy sources (R.E.S)," *Appl. Energy*, vol. 86, pp. 516–527, 2009.
- [8] T. Senjyu, R. Sakamoto, N. Urasaki, T. Funabashi, H. Fujita, and H. Sekine, "Output power leveling of wind turbine generator for all operating regions by pitch angle control," *IEEE Trans. Energy Convers.*, vol. 21, pp. 467–475, 2006.
- [9] T. Senjyu, D. Hayashi, A. Yona, N. Urasaki, and T. Funabashi, "Optimal configuration of power generating systems in isolated Island with renewable energy," *Renewable Energy*, vol. 32, no. 11, pp. 1917–1933, 2007.
- [10] T. Kinjo, T. Senjyu, N. Urasaki, and H. Fujita, "Output leveling of renewable energy by electric double-layer capacitor applied for energy storage system," *IEEE Trans. Energy Convers.*, vol. 21, pp. 221–227, 2006.
- [11] T. Senjyu, T. Kaneko, A. Uehara, A. Yona, H. Sekine, and C.-H. Kim, "Output power control for large wind power penetration in small power system," *Renewable Energy*, vol. 34, pp. 2334–2343, 2011.
- [12] T. Senjyu, T. Nakaji, K. Uezato, and T. Funabashi, "A hybrid power system using alternative energy facilities in isolated Island," *IEEE Trans. Energy Convers.*, vol. 20, pp. 406–414, 2005.
- [13] K. Moslehi and R. Kumar, "A reliability perspective of the smart grid," *IEEE Trans. Smart Grid*, vol. 1, no. 1, pp. 57–64, Jun. 2010.
- [14] F. Li, W. Qiao, H. Sun, H. Wan, J. Wang, Y. Xia, Z. Xu, and P. Zhang, "Smart transmission grid: Vision and framework," *IEEE Trans. Smart Grid*, vol. 1, no. 2, pp. 168–177, Sep., 2010.
- [15] T. Goya, T. Senjyu, A. Yona, S. Chakraborty, N. Urasaki, T. Funabashi, and C.-H. Kim, "Optimal operation of thermal unit and battery by using smart grid," in *Proc. Int. Conf. Electr. Eng.*, 2010, no. PSO&C-05.
- [16] M. Tokudome, T. Senjyu, A. Yona, and T. Funabashi, "Frequency and voltage control of isolated Island power systems by decentralized controllable loads," in *Proc. IEEE Transm. Distrib. Conf. Asia*, Seoul, Korea, Oct. 2009, p. 4.
- [17] T. Senjyu, M. Tokudome, A. Yona, and T. Funabashi, "A frequency control approach by decentralized controllable loads in small power systems," *IEEE Trans. PE*, vol. 129, no. 9, pp. 1074–1080, 2009.
- [18] K. Uchida, T. Senjyu, N. Urasaki, and A. Yona, "Installation effect by solar heater system using solar radiation forecasting," in *Proc. IEEE Transm. Distrib. Conf. Asia*, Seoul, Korea, Oct. 2009, p. 4.

**Kennichi Tanaka** (S'08) was born in Kumamoto, Japan, in 1987. He received the B.S. degree in the Department of Electrical and Electronics Engineering, Faculty of Engineering, University of the Ryukyus, Japan.

His research concerns operation of distributed generations.

Mr. Tanaka is a student member of the Institute of Electrical Engineers of Japan.

**Kosuke Uchida** (S'08) received the B.S. degree in electrical engineering from the University of the Ryukyus, Okinawa, Japan, in 2009, in electrical and electronics engineering. He is currently working toward the Ph.D. degree in the Department of Electrical and Electronics Engineering, Faculty of Engineering, University of the Ryukyus.

His current research concerns operation of solar utilization systems.

**Kazuki Ogimi** (S'10) received the B.S. degree in electrical engineering from the University of the Ryukyus, Okinawa, Japan, in 2011, in electrical and electronics engineering. He is currently working toward the M.S. degree in the Department of Electrical and Electronics Engineering, Faculty of Engineering, University of the Ryukyus.

His current research concerns the operation of renewable energy systems considering forecasted error.

**Tomonori Goya** (S'09) received the B.S. degree in electrical engineering from the University of the Ryukyus, Okinawa, Japan, in 2010, in electrical and electronics engineering. He is currently working toward the M.S. degree in the Department of Electrical and Electronics Engineering, Faculty of Engineering, University of the Ryukyus. His current research concerns the operation of transmission system.

**Atsushi Yona** (S'06) was born in Okinawa, Japan, in 1982. He received the B.S., M.S., and Ph.D. degrees in electrical engineering from the University of the Ryukyus, Okinawa, Japan, in 2006, 2008, and 2010, respectively.

He is currently an Assistant Professor at the University of the Ryukyus. His research interests include wind and photovoltaic energies, and neural networks.

Dr. Yona is a member of IEEEJ.

**Tomonobu Senjyu** (A'89–M'02–SM'06) was born in Saga, Japan, in 1963. He received the B.S. and M.S. degrees from the University of the Ryukyus, Okinawa, Japan, in 1986 and 1988, respectively, and the Ph.D. degree from Nagoya University, Nagoya, Japan, in 1994, all in electrical engineering.

In 1988, he joined the University of the Ryukyus, where he is now a Professor. His research interests include stability of ac machines, advanced control of electrical machines, and power electronics.

Prof. Senjyu is a Member of the Institute of Electrical Engineers of Japan. He is also a Chartered Engineer in the U.K.

**Toshihisa Funabashi** (M'90–SM'96) was born in Aichi, Japan, in 1951. He received the B.S. degree from Nagoya University, Aichi, in 1975, and the Ph.D. degree from Doshisha University, Kyoto, Japan, in 2000, both in electrical engineering.

He has been with the Power System Engineering Division, Meidensha Corporation, Tokyo, Japan, since 1975, and is now a Senior Engineer, engaged in research on power system analysis.

Dr. Funabashi is a member of IET. He is also a Chartered Engineer in the U.K.

**Chul-Hwan Kim** (M'90–SM'04) was born in Korea in 1961. He received the B.S., M.S., and Ph.D. degrees in electrical engineering from Sungkyunkwan University, Suwon City, Korea, in 1982, 1984, and 1990, respectively.

In 1990, he was a Full-Time Lecturer with Cheju National University, Cheju, Korea. He has been a Visiting Academic at the University of Bath, Bath, U.K., in 1996, 1998, and 1999. Currently, he is a Professor in the School of Electrical and Computer Engineering, Sungkyukwan University. His research interests include power system protection, artificial intelligence application to protection and control, the modeling/protection of underground cable, and EMTP software.